

## CMOS Programmable Low Power Single Operational Amplifier

- Offset null capability (by external compensation)
- Dynamic characteristics adjustable  $I_{SET}$
- Consumption current and dynamic parameters are stable regarding the voltage power supply variations
- Output voltage can swing to ground
- Very large  $I_{SET}$  range
- Stable and low offset voltage
- Three input offset voltage selections

### Description

The TS271 is a low cost, low power single operational amplifier designed to operate with single or dual supplies. This operational amplifier uses the ST silicon gate CMOS process giving it an excellent consumption-speed ratio. This amplifier is ideally suited for low consumption applications.

The power supply is externally programmable with a resistor connected between pins 8 and 4. It allows to choose the best consumption-speed ratio and supply current can be minimized according to the required speed. This device is specified for the following  $I_{SET}$  current values: 1.5 $\mu$ A, 25 $\mu$ A, 130 $\mu$ A.

This CMOS amplifier offers very high input impedance and extremely low input currents. The major advantage versus JFET devices is the very low input currents drift with temperature see [Figure 8](#), [Figure 19](#), [Figure 30](#).

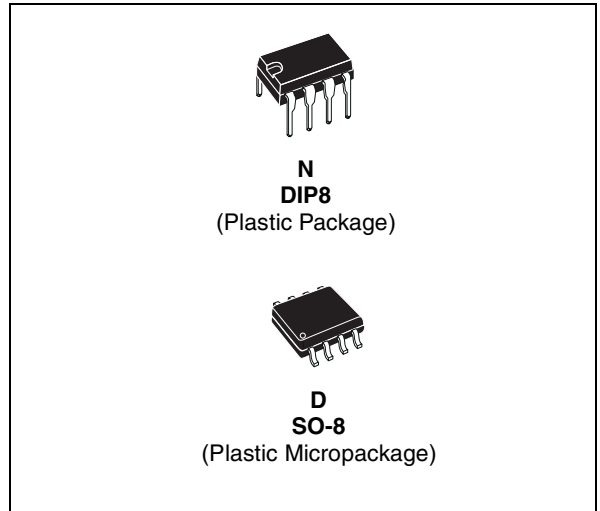

### Pin Connections (top view)

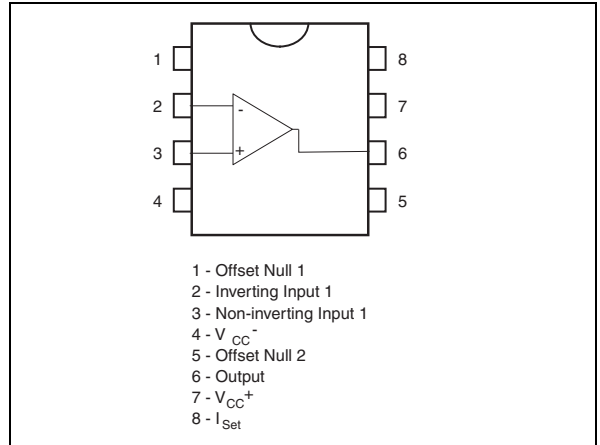

### Order Codes

Part Number	Temperature Range	Package	Packaging
TS271CN/ACN	0°C, +70°C	DIP	Tube
TS271CD/CDT/ACD/ACDT		SO	Tube and Tape & Reel
TS271IN/AIN/	-40°C, +125°C	DIP	Tube
TS271ID/IDT/AID/AIDT/BID/BIDT		SO	Tube and Tape & Reel
TS271BMD	-55°C, +125°C	SO	Tube

# 1 Block Diagram

Figure 1. Application block diagram

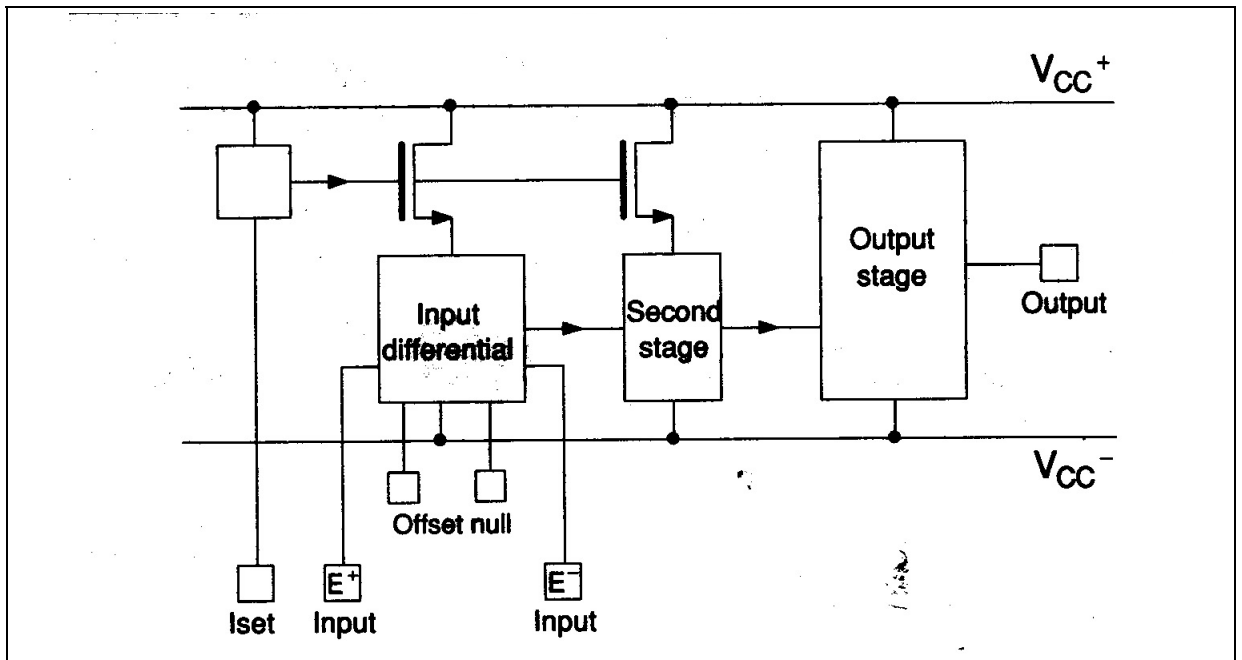

## 2 Absolute Maximum Ratings

**Table 1. Key parameters and their absolute maximum ratings**

Symbol	Parameter	TS271C/AC/BC	TS271I/AI/BI	TS271M/AM/BM	Unit
$V_{CC}^+$	Supply Voltage <sup>1</sup>	18			V
$V_{id}$	Differential Input Voltage <sup>2</sup>	±18			V
$V_i$	Input Voltage <sup>3</sup>	-0.3 to 18			V
$I_o$	Output Current for $V_{CC}^+ \geq 15V$	±30			mA
$I_{in}$	Input Current	±5			mA
$T_{oper}$	Operating Free-Air Temperature Range	0 to +70	-40 to +125	-55 to +125	°C
$T_{stg}$	Storage Temperature Range	-65 to +150			°C

- 1) All values, except differential voltage are with respect to network ground terminal.
- 2) Differential voltages are the non-inverting input terminal with respect to the inverting input terminal.
- 3) The magnitude of the input and the output voltages must never exceed the magnitude of the positive supply voltage.

**Table 2. Operating conditions**

Symbol	Parameter	Value	Unit
$V_{CC}^+$	Supply Voltage	3 to 16	V
$V_{icm}$	Common Mode Input Voltage Range	0 to $V_{CC}^+ - 1.5$	V

Figure 2. Schematic Diagram

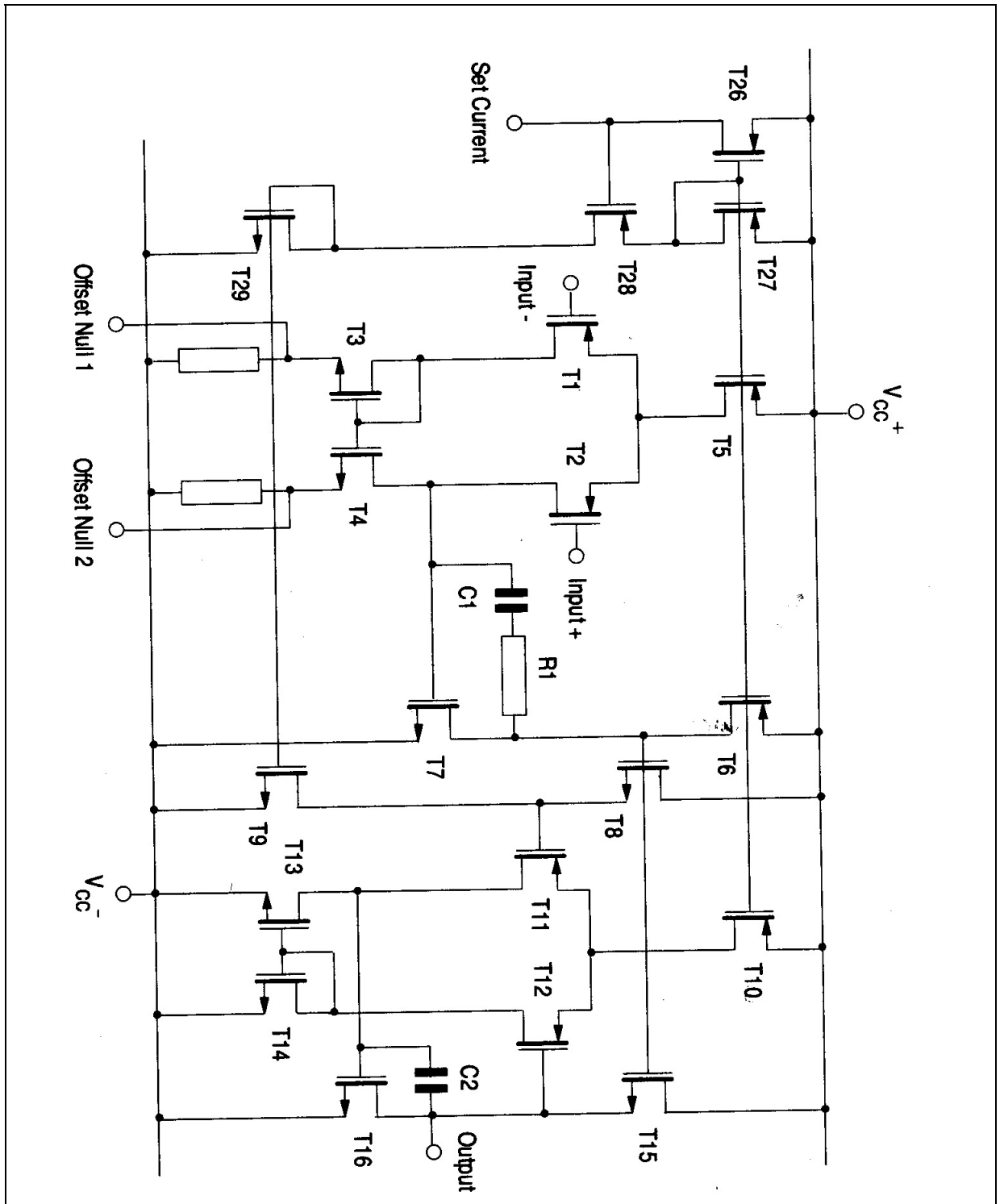

Figure 3. Offset voltage null circuit

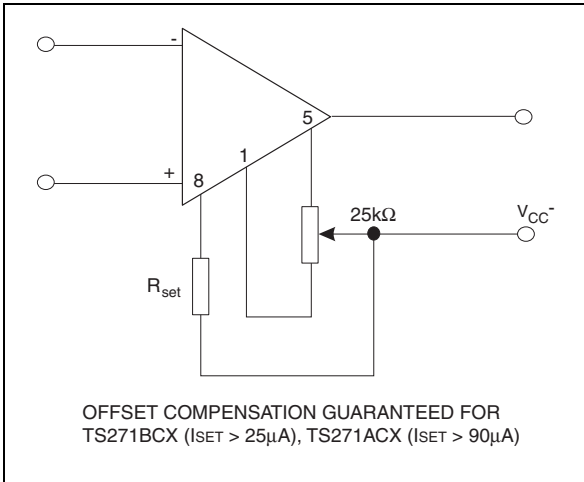

Figure 5. Resistor biasing

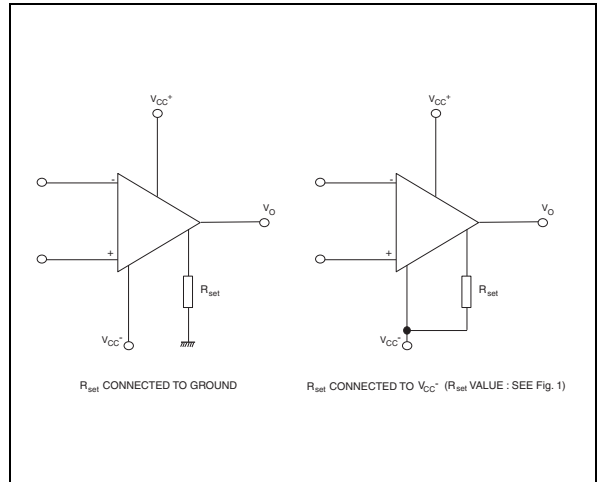

Figure 4. Offset voltage null circuit

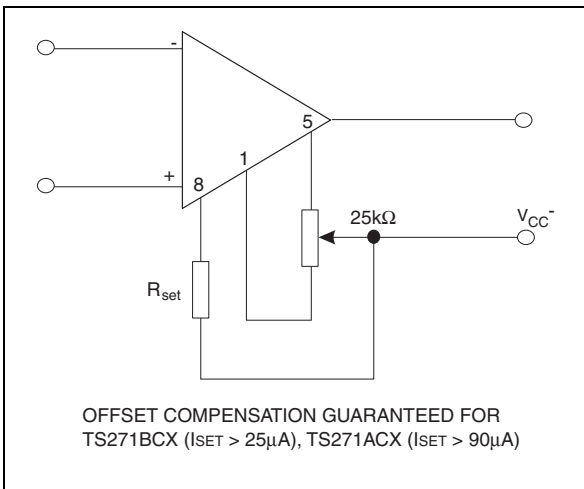
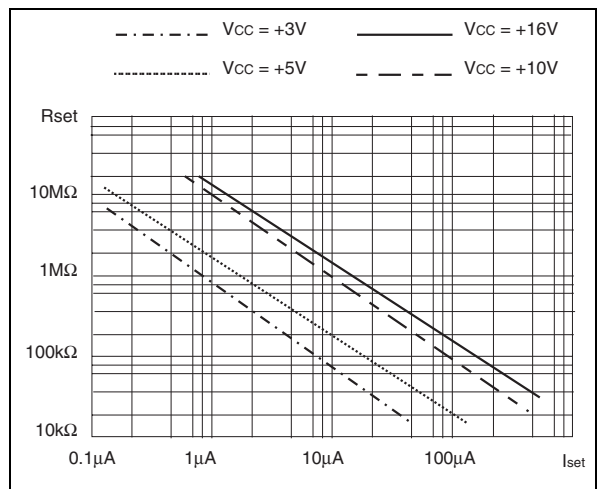

Figure 6. Rset connected to Vcc-



### 3 Electrical Characteristics

Table 3. for  $I_{SET} = 1.5\mu A$  -  $V_{CC}^+ = +10V$ ,  $V_{CC}^- = 0V$ ,  $T_{amb} = +25^\circ C$  (unless otherwise specified)

Symbol	Parameter	TS271C/AC/BC			TS271I/AI/BI TS271M/AM/BM			Unit
		Min.	Typ.	Max.	Min.	Typ.	Max.	
$V_{io}$	Input Offset Voltage $V_O = 1.4V$ , $V_{ic} = 0V$ TS271C/I/M TS271AC/AI/AM TS271BC/BI/BM $T_{min} \leq T_{amb} \leq T_{max}$ TS271C/I/M TS271AC/AI/AM TS271BC/BI/BM		1.1 0.9 0.25	10 5 2 12 6.5 3		1.1 0.9 0.25	10 5 2 12 6.5 3.5	mV
$DV_{io}$	Input Offset Voltage Drift		2			2		$\mu V/^\circ C$
$I_{io}$	Input Offset Current note 1 $V_{ic} = 5V$ , $V_O = 5V$ $T_{min} \leq T_{amb} \leq T_{max}$		1	100		1	200	pA
$I_{ib}$	Input Bias Current - see note 1 $V_{ic} = 5V$ , $V_O = 5V$ $T_{min} \leq T_{amb} \leq T_{max}$		1	150		1	300	pA
$V_{OH}$	High Level Output Voltage $V_{id} = 100mV$ , $R_L = 1M\Omega$ $T_{min} \leq T_{amb} \leq T_{max}$	8.8 8.7	9		8.8 8.6	9		V
$V_{OL}$	Low Level Output Voltage $V_{id} = -100mV$			50			50	mV
$A_{vd}$	Large Signal Voltage Gain $V_{ic} = 5V$ , $R_L = 1M\Omega$ , $V_o = 1V$ to $6V$ $T_{min} \leq T_{amb} \leq T_{max}$	30 20	100		30 20	100		V/mV
GBP	Gain Bandwidth Product $A_v = 40dB$ , $R_L = 1M\Omega$ , $C_L = 100pF$ , $f_{in} = 100kHz$		0.1			0.1		MHz
CMR	Common Mode Rejection Ratio $V_{ic} = 1V$ to $7.4V$ , $V_o = 1.4V$	60	80		60	80		dB
SVR	Supply Voltage Rejection Ratio $V_{CC}^+ = 5V$ to $10V$ , $V_o = 1.4V$	60	80		60	80		dB
$I_{CC}$	Supply Current (per amplifier) $A_v = 1$ , no load, $V_o = 5V$ $T_{min} \leq T_{amb} \leq T_{max}$		10	15 17		10	15 18	$\mu A$
$I_o$	Output Short Circuit Current $V_o = 0V$ , $V_{id} = 100mV$		60			60		mA
$I_{sink}$	Output Sink Current $V_o = V_{CC}$ , $V_{id} = -100mV$		45			45		mA
SR	Slew Rate at Unity Gain $R_L = 1M\Omega$ , $C_L = 100pF$ , $V_i = 3$ to $7V$		0.04			0.04		$V/\mu s$
$\phi_m$	Phase Margin at Unity Gain $A_v = 40dB$ , $R_L = 1M\Omega$ $C_L = 10pF$ $C_L = 100pF$		35 10			35 10		Degrees
$K_{OV}$	Overshoot Factor $A_v = 40dB$ , $R_L = 1M\Omega$ $C_L = 10pF$ $C_L = 100pF$		40 70			40 70		%
$e_n$	Equivalent Input Noise Voltage $f = 1kHz$ , $R_s = 100\Omega$		30			30		$\frac{nV}{\sqrt{Hz}}$

1) Maximum values including unavoidable inaccuracies of the industrial test.

Typical characteristics for  $I_{SET} = 1.5\mu A$

Figure 7. Supply current versus supply voltage

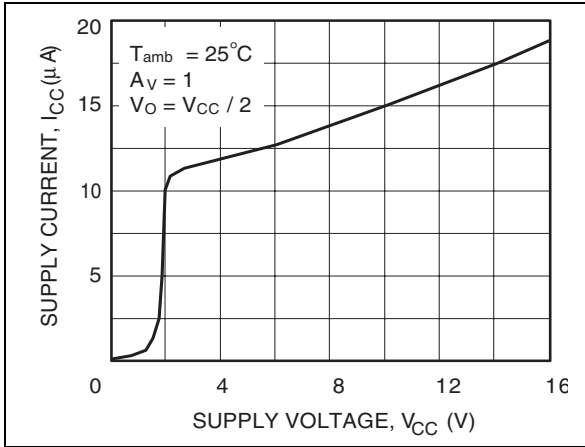

Figure 8. Input bias current versus free air temperature

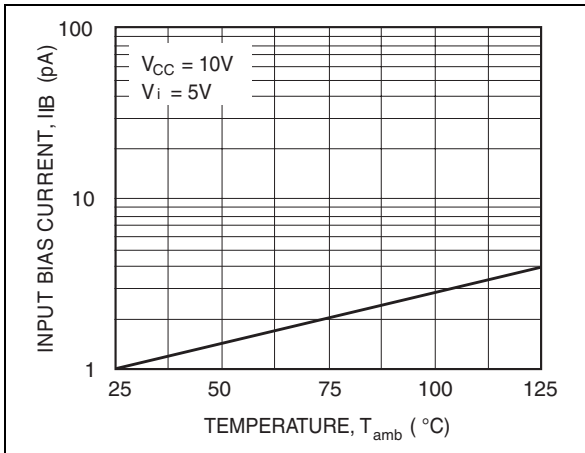

Figure 9. High level output voltage versus high level output current

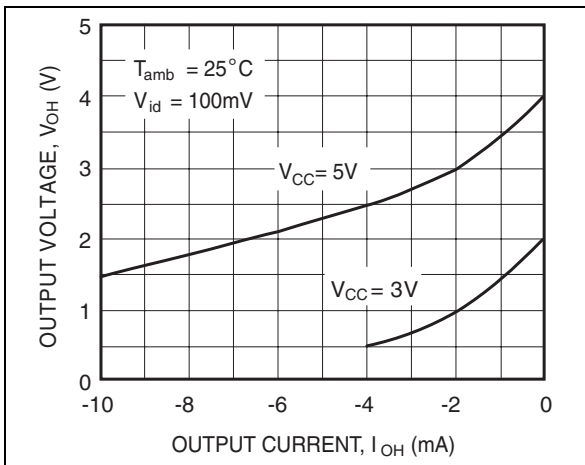

Figure 10. High level output voltage versus high level output current

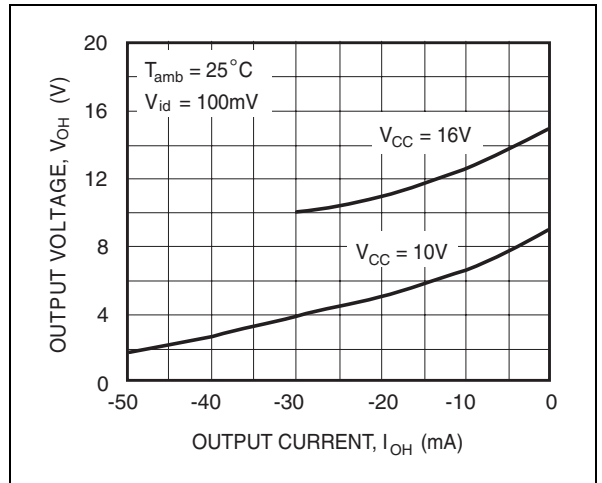

Figure 11. Low level output voltage versus low level output current

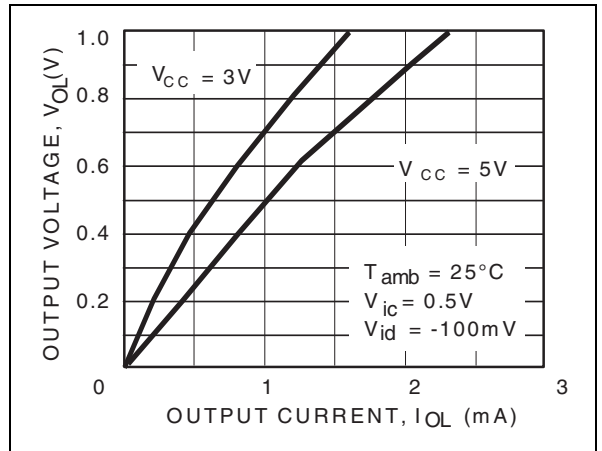

Figure 12. Low level output voltage versus low level output current

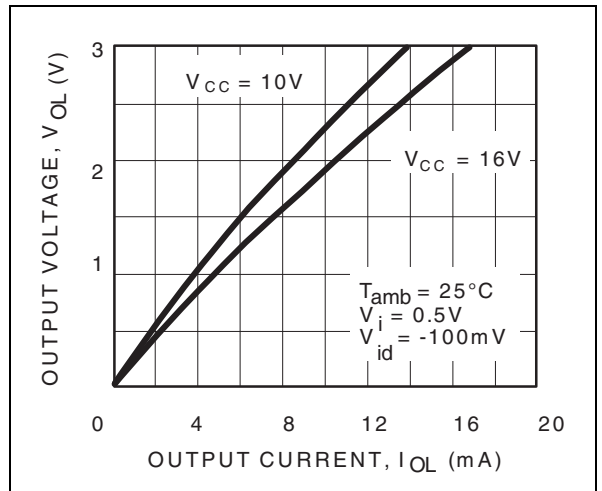

Figure 13. Open loop frequency response and phase shift

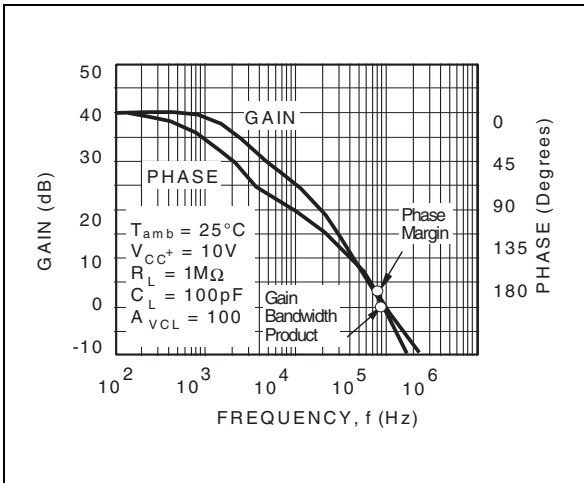

Figure 16. Phase margin versus capacitive load

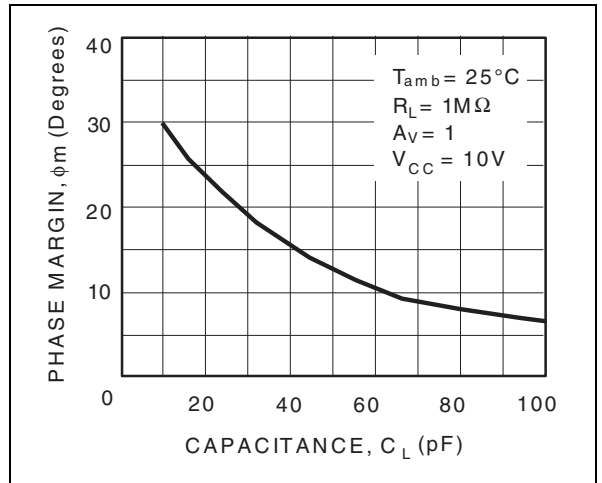

Figure 14. Gain bandwidth product versus supply voltage

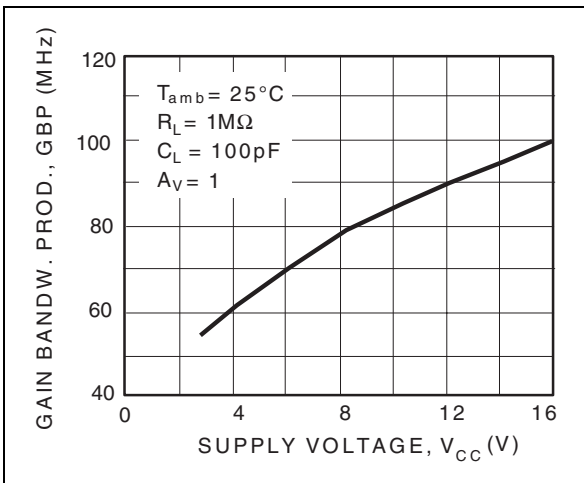

Figure 17. Slew rate versus supply voltage

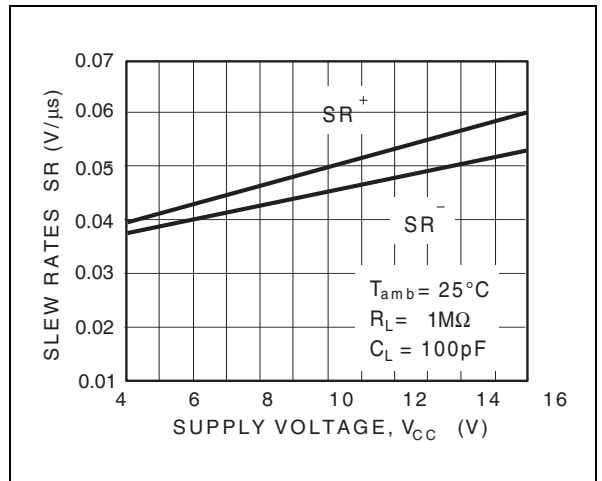
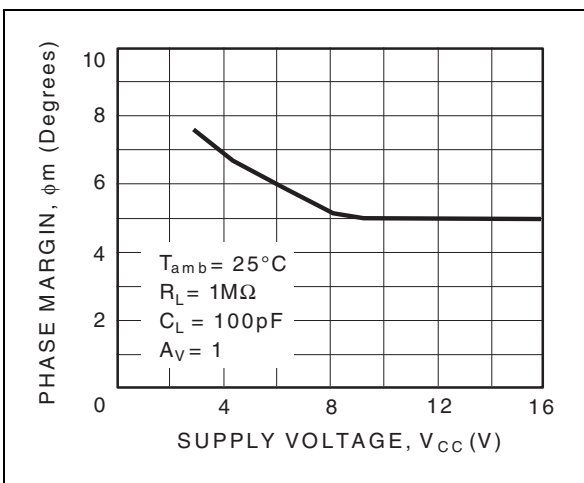

Figure 15. Phase margin versus supply voltage





## 4 Electrical Characteristics

Table 4. for  $I_{SET} = 25\mu A$  -  $V_{CC}^+ = +10V$ ,  $V_{CC}^- = 0V$ ,  $T_{amb} = +25^\circ C$  (unless otherwise specified)

Symbol	Parameter	TS271C/AC/BC			TS271I/AI/BI TS271M/AM/BM			Unit
		Min.	Typ.	Max.	Min.	Typ.	Max.	
$V_{io}$	Input Offset Voltage $V_O = 1.4V$ , $V_{ic} = 0V$ $T_{min} \leq T_{amb} \leq T_{max}$		1.1 0.9 0.25	10 5 2 12 6.5 3		1.1 0.9 0.25	10 5 2 12 6.5 3.5	mV
$DV_{io}$	Input Offset Voltage Drift		2			2		$\mu V/^\circ C$
$I_{io}$	Input Offset Current note 1 $V_{ic} = 5V$ , $V_O = 5V$ $T_{min} \leq T_{amb} \leq T_{max}$		1	100		1	200	pA
$I_{ib}$	Input Bias Current - see note 1 $V_{ic} = 5V$ , $V_O = 5V$ $T_{min} \leq T_{amb} \leq T_{max}$		1	150		1	300	pA
$V_{OH}$	High Level Output Voltage $V_{id} = 100mV$ , $R_L = 100k\Omega$ $T_{min} \leq T_{amb} \leq T_{max}$	8.7 8.6	8.9		8.7 8.5	8.9		V
$V_{OL}$	Low Level Output Voltage $V_{id} = -100mV$			50			50	mV
$A_{vd}$	Large Signal Voltage Gain $V_{ic} = 5V$ , $R_L = 100k\Omega$ , $V_O = 1V$ to $6V$ $T_{min} \leq T_{amb} \leq T_{max}$	30 20	50		30 10	50		V/mV
GBP	Gain Bandwidth Product $A_v = 40dB$ , $R_L = 100k\Omega$ , $C_L = 100pF$ , $f_{in} = 100kHz$		0.7			0.7		MHz
CMR	Common Mode Rejection Ratio $V_{ic} = 1V$ to $7.4V$ , $V_O = 1.4V$	60	80		60	80		dB
SVR	Supply Voltage Rejection Ratio $V_{CC}^+ = 5V$ to $10V$ , $V_O = 1.4V$	60	80		60	80		dB
$I_{CC}$	Supply Current (per amplifier) $A_v = 1$ , no load, $V_O = 5V$ $T_{min} \leq T_{amb} \leq T_{max}$		150	200 250		150	200 300	$\mu A$
$I_o$	Output Short Circuit Current $V_O = 0V$ , $V_{id} = 100mV$		60			60		mA
$I_{sink}$	Output Sink Current $V_O = V_{CC}$ , $V_{id} = -100mV$		45			45		mA
SR	Slew Rate at Unity Gain $R_L = 100k\Omega$ , $C_L = 100pF$ , $V_i = 3$ to $7V$		0.6			0.6		$V/\mu s$
$\phi_m$	Phase Margin at Unity Gain $A_v = 40dB$ , $R_L = 100k\Omega$ $C_L = 10pF$ $C_L = 100pF$		50 30			50 30		Degrees
$K_{OV}$	Overshoot Factor $A_v = 40dB$ , $R_L = 100k\Omega$ $C_L = 10pF$ $C_L = 100pF$		30 50			30 50		%
$e_n$	Equivalent Input Noise Voltage $f = 1kHz$ , $R_s = 100\Omega$		38			38		$\frac{nV}{\sqrt{Hz}}$

1) Maximum values including unavoidable inaccuracies of the industrial test.

Typical characteristics for  $I_{SET} = 25\mu A$

Figure 18. Supply current versus supply voltage

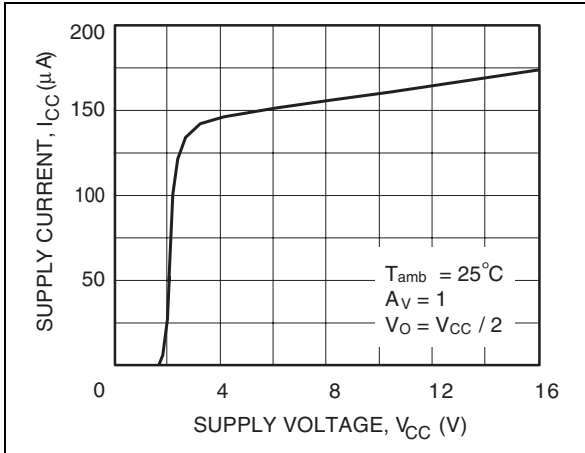

Figure 19. Input bias current versus free air temperature

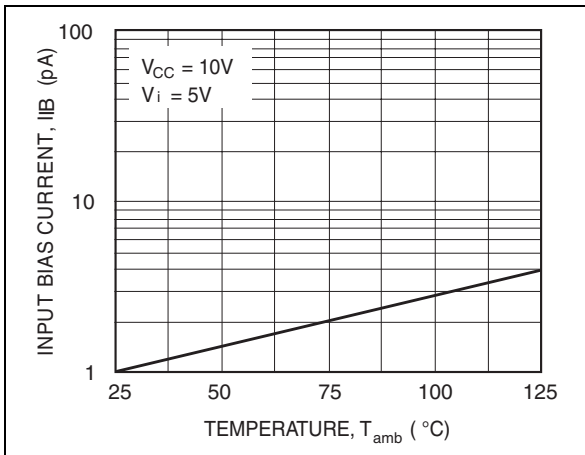

Figure 20. High level output voltage versus high level output current

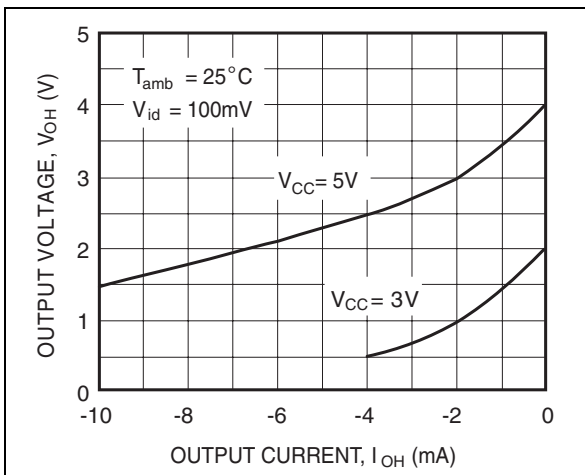

Figure 21. High level output voltage versus high level output current

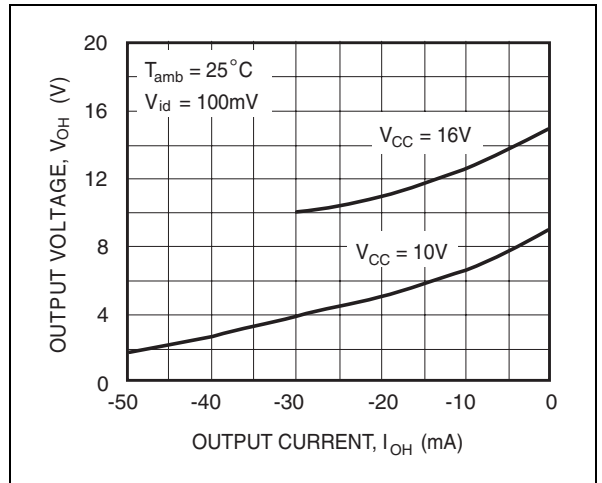

Figure 22. Low level output voltage versus low level output current

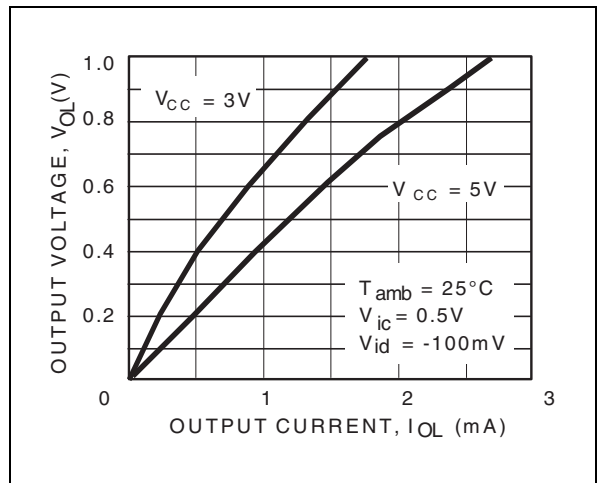

Figure 23. Low level output voltage versus low level output current

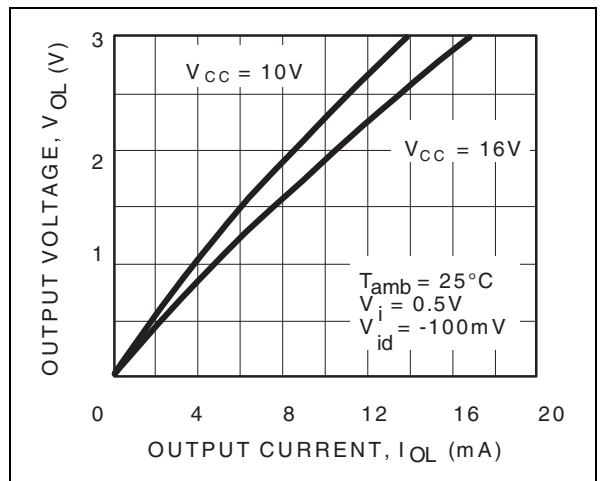

Figure 24. Open loop frequency response and phase shift

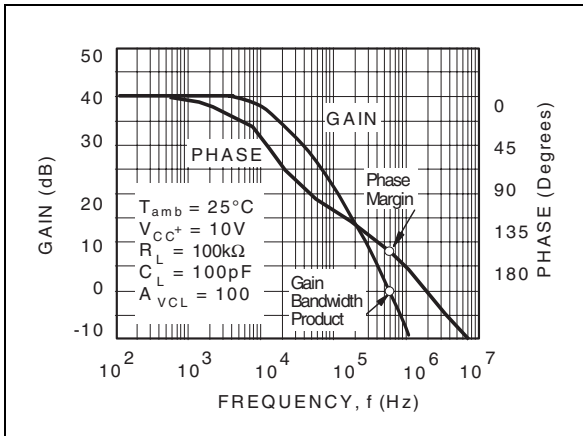

Figure 27. Phase margin versus capacitive load

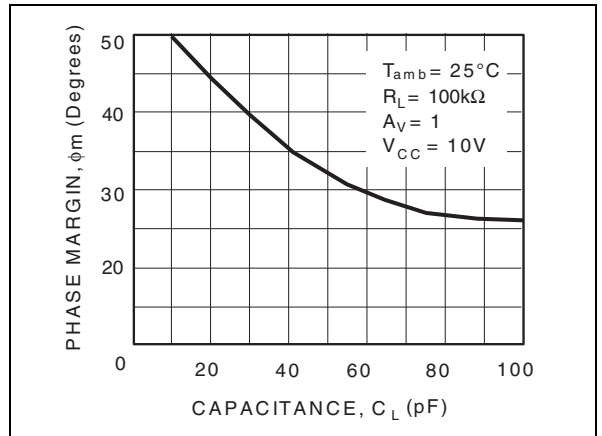

Figure 25. Gain bandwidth product versus supply voltage

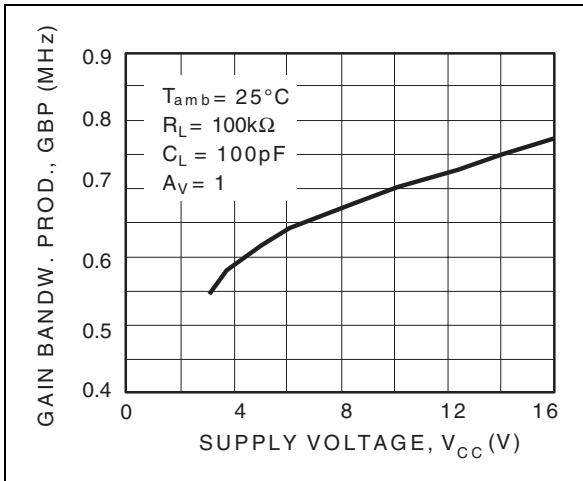

Figure 28. Slew rate versus supply voltage

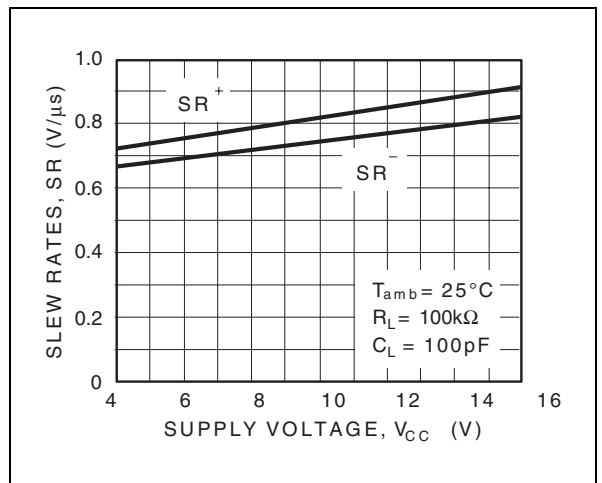
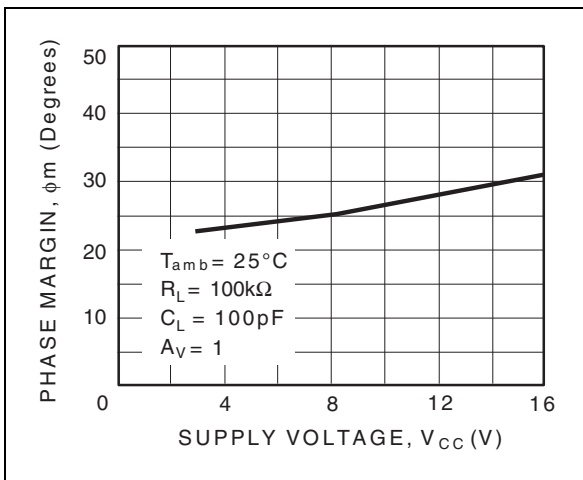

Figure 26. Phase margin versus supply voltage



## 5 Electrical Characteristics

Table 5. for  $I_{SET} = 130\mu A$  -  $V_{CC^+} = +10V$ ,  $V_{CC^-} = 0V$ ,  $T_{amb} = +25^{\circ}C$  (unless otherwise specified)

Symbol	Parameter	TS271C/AC/BC			TS271I/AI/BI TS271M/AM/BM			Unit
		Min.	Typ.	Max.	Min.	Typ.	Max.	
$V_{io}$	Input Offset Voltage $V_O = 1.4V$ , $V_{ic} = 0V$ $T_{min} \leq T_{amb} \leq T_{max}$		1.1 0.9 0.25	10 5 2 12 6.5 3		1.1 0.9 0.25	10 5 2 12 6.5 3.5	mV
$DV_{io}$	Input Offset Voltage Drift		2			2		$\mu V/^{\circ}C$
$I_{io}$	Input Offset Current note 1 $V_{ic} = 5V$ , $V_O = 5V$ $T_{min} \leq T_{amb} \leq T_{max}$		1	100		1	200	pA
$I_{ib}$	Input Bias Current - see note 1 $V_{ic} = 5V$ , $V_O = 5V$ $T_{min} \leq T_{amb} \leq T_{max}$		1	150		1	300	pA
$V_{OH}$	High Level Output Voltage $V_{id} = 100mV$ , $R_L = 10k\Omega$ $T_{min} \leq T_{amb} \leq T_{max}$	8.2 8.1	8.4		8.2 8	8.4		V
$V_{OL}$	Low Level Output Voltage $V_{id} = -100mV$			50			50	mV
$A_{vd}$	Large Signal Voltage Gain $V_{ic} = 5V$ , $R_L = 10k\Omega$ , $V_O = 1V$ to $6V$ $T_{min} \leq T_{amb} \leq T_{max}$	10 7	15		10 6	15		V/mV
GBP	Gain Bandwidth Product $A_v = 40dB$ , $R_L = 10k\Omega$ , $C_L = 100pF$ , $f_{in} = 100kHz$		2.3			2.3		MHz
CMR	Common Mode Rejection Ratio $V_{ic} = 1V$ to $7.4V$ , $V_O = 1.4V$	60	80		60	80		dB
SVR	Supply Voltage Rejection Ratio $V_{CC^+} = 5V$ to $10V$ , $V_O = 1.4V$	60	70		60	70		dB
$I_{CC}$	Supply Current (per amplifier) $A_v = 1$ , no load, $V_O = 5V$ $T_{min} \leq T_{amb} \leq T_{max}$		800	1300 1400		800	1300 1500	$\mu A$
$I_o$	Output Short Circuit Current $V_O = 0V$ , $V_{id} = 100mV$		60			60		mA
$I_{sink}$	Output Sink Current $V_O = V_{CC^-}$ , $V_{id} = -100mV$		45			45		mA
SR	Slew Rate at Unity Gain $R_L = 10k\Omega$ , $C_L = 100pF$ , $V_i = 3$ to $7V$		4.5			4.5		V/ $\mu s$
$\phi_m$	Phase Margin at Unity Gain $A_v = 40dB$ , $R_L = 10k\Omega$ $C_L = 10pF$ $C_L = 100pF$		65 30			65 30		Degrees
$K_{OV}$	Overshoot Factor $A_v = 40dB$ , $R_L = 10k\Omega$ $C_L = 10pF$ $C_L = 100pF$		30 50			30 50		%
$e_n$	Equivalent Input Noise Voltage $f = 1kHz$ , $R_s = 100\Omega$		30			30		$\frac{nV}{\sqrt{Hz}}$

1) Maximum values including unavoidable inaccuracies of the industrial test.

Typical characteristics for  $I_{SET} = 130\mu A$

Figure 29. Supply current (each amplifier) versus supply voltage

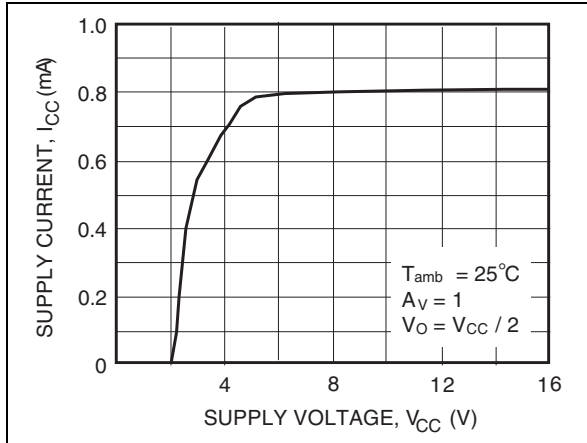

Figure 30. Input bias current versus free air temperature

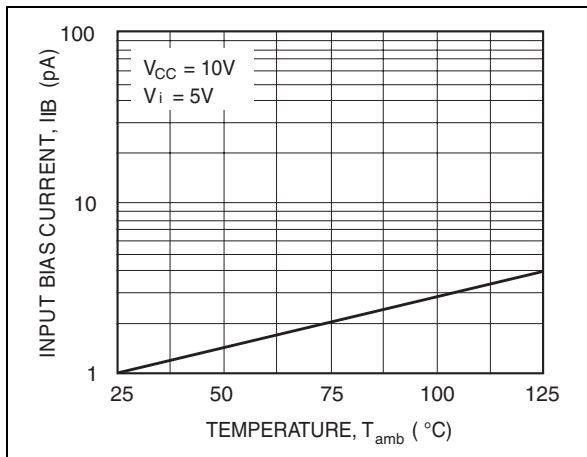

Figure 31. High level output voltage versus high level output current

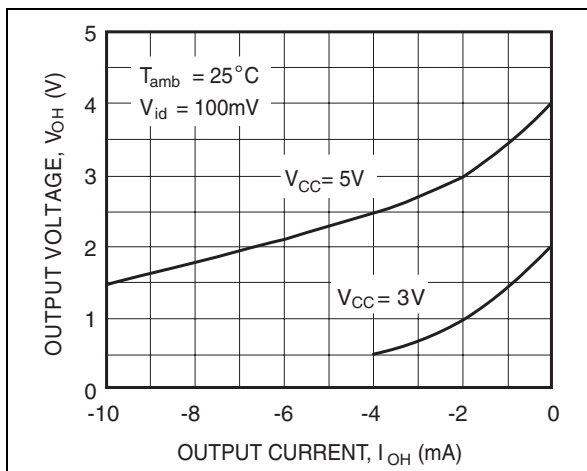

Figure 32. High level output voltage versus high level output current

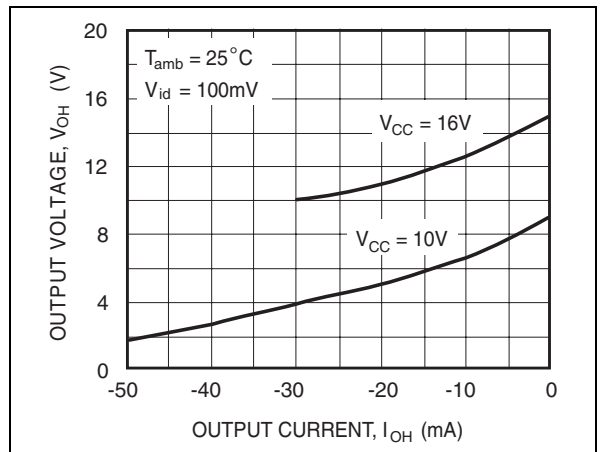

Figure 33. Low level output voltage versus low level output current

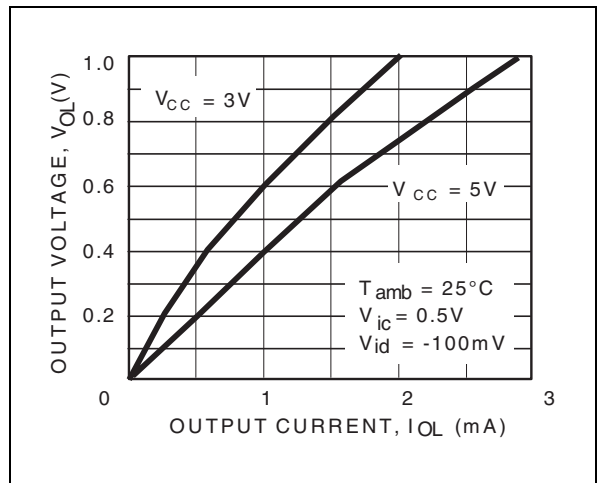

Figure 34. Low level output voltage versus low level output current

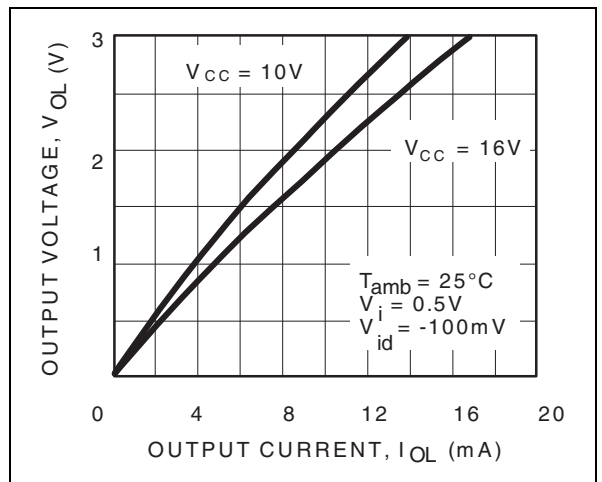

Figure 35. Open loop frequency response and phase shift

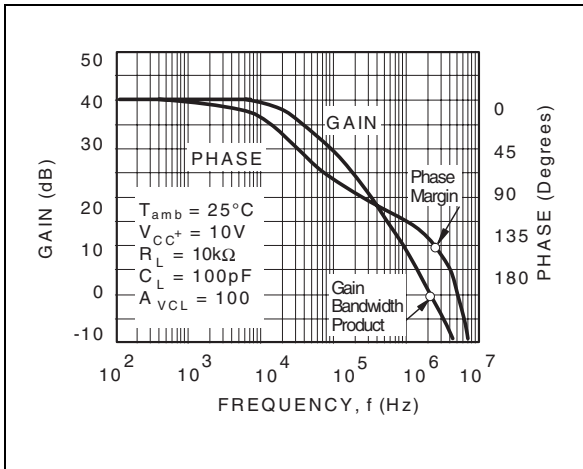

Figure 38. Phase margin versus capacitive load

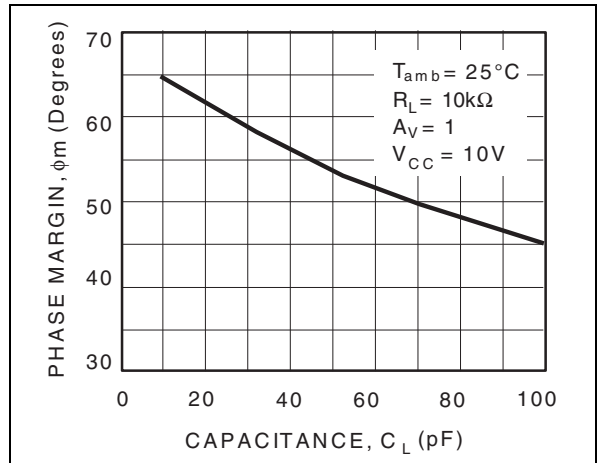

Figure 36. Gain bandwidth product versus supply voltage

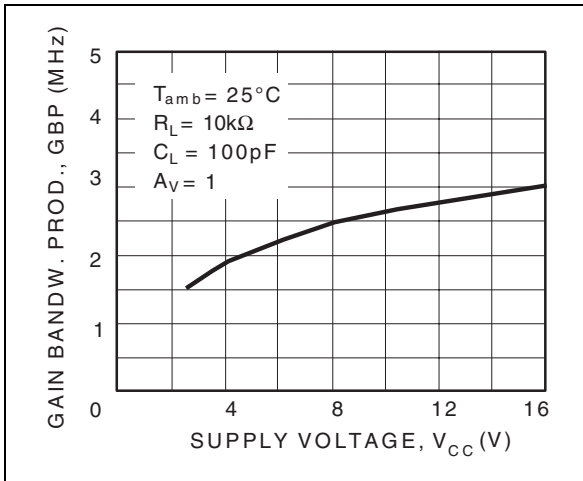

Figure 39. Slew rate versus supply voltage

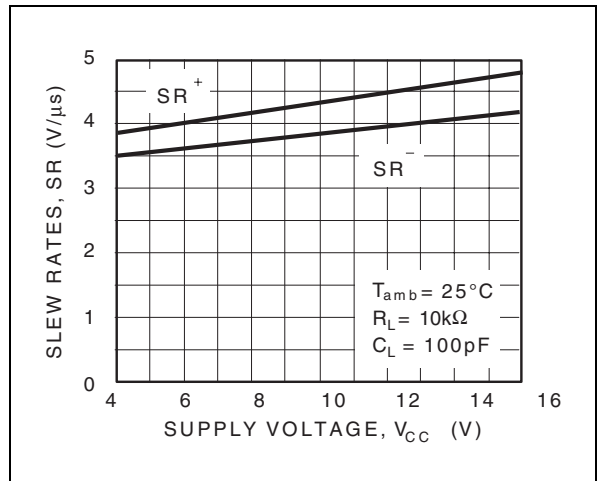
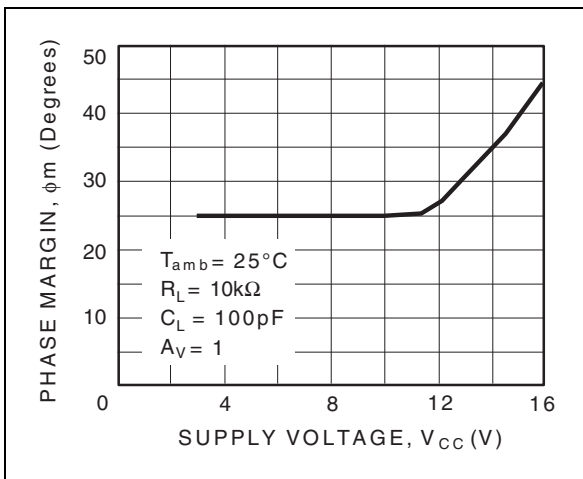

Figure 37. Phase margin versus supply voltage



## 6 Package Mechanical Data

**Plastic DIP-8 MECHANICAL DATA**

DIM.	mm.			inch		
	MIN.	TYP	MAX.	MIN.	TYP.	MAX.
A		3.3			0.130	
a1	0.7			0.028		
B	1.39		1.65	0.055		0.065
B1	0.91		1.04	0.036		0.041
b		0.5			0.020	
b1	0.38		0.5	0.015		0.020
D			9.8			0.386
E		8.8			0.346	
e		2.54			0.100	
e3		7.62			0.300	
e4		7.62			0.300	
F			7.1			0.280
l			4.8			0.189
L		3.3			0.130	
Z	0.44		1.6	0.017		0.063

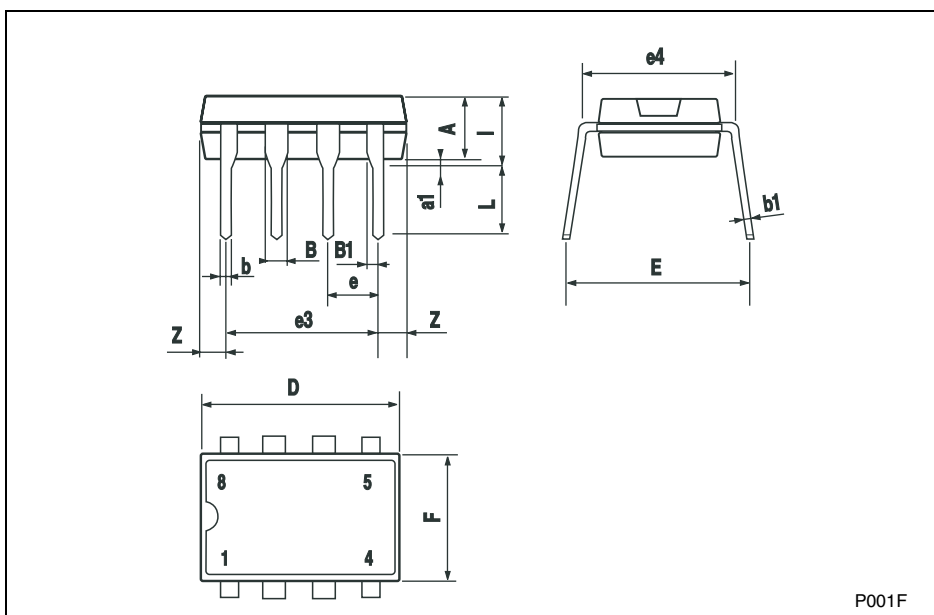

Package Mechanical Data

SO-8 MECHANICAL DATA

DIM.	mm.			inch		
	MIN.	TYP.	MAX.	MIN.	TYP.	MAX.
A	1.35		1.75	0.053		0.069
A1	0.10		0.25	0.04		0.010
A2	1.10		1.65	0.043		0.065
B	0.33		0.51	0.013		0.020
C	0.19		0.25	0.007		0.010
D	4.80		5.00	0.189		0.197
E	3.80		4.00	0.150		0.157
e		1.27			0.050	
H	5.80		6.20	0.228		0.244
h	0.25		0.50	0.010		0.020
L	0.40		1.27	0.016		0.050
k	8° (max.)					
ddd			0.1			0.04

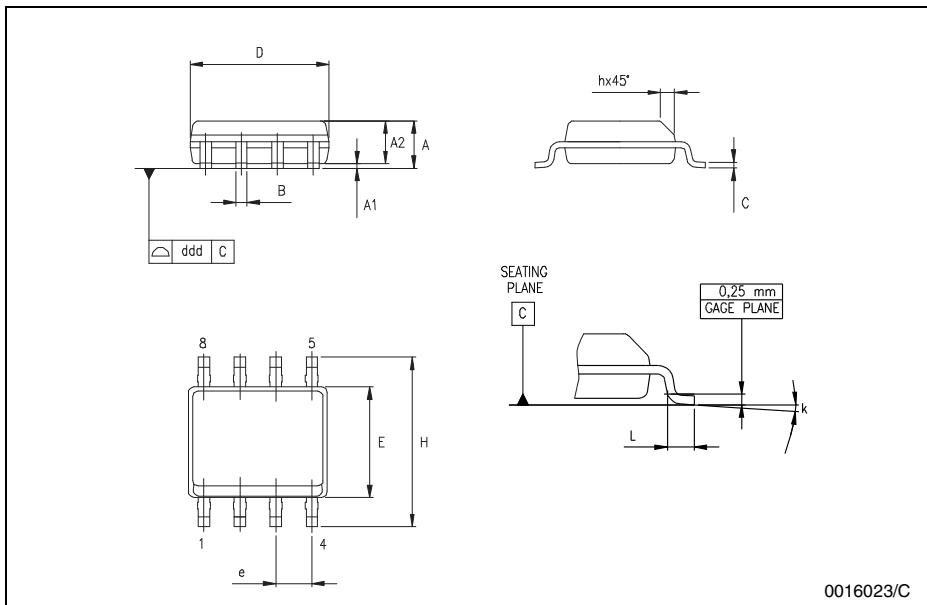

0016023/C



## 7 Revision History

Date	Revision	Description of Changes
01 Nov. 2001	1	First Release
01 March 2005	2	<ul style="list-style-type: none"><li>• Application block diagram updated on <a href="#">Figure 2 on page 4</a></li><li>• Schematic Diagram updated on <a href="#">Figure 4 on page 5</a></li></ul>

Information furnished is believed to be accurate and reliable. However, STMicroelectronics assumes no responsibility for the consequences of use of such information nor for any infringement of patents or other rights of third parties which may result from its use. No license is granted by implication or otherwise under any patent or patent rights of STMicroelectronics. Specifications mentioned in this publication are subject to change without notice. This publication supersedes and replaces all information previously supplied. STMicroelectronics products are not authorized for use as critical components in life support devices or systems without express written approval of STMicroelectronics.

The ST logo is a registered trademark of STMicroelectronics  
All other names are the property of their respective owners

© 2005 STMicroelectronics - All rights reserved

STMicroelectronics group of companies

Australia - Belgium - Brazil - Canada - China - Czech Republic - Finland - France - Germany - Hong Kong - India - Israel - Italy - Japan - Malaysia - Malta - Morocco - Singapore - Spain - Sweden - Switzerland - United Kingdom - United States of America

[www.st.com](http://www.st.com)