

UNI-T®



Certificate No. 956661

UTG1000A

User Manual

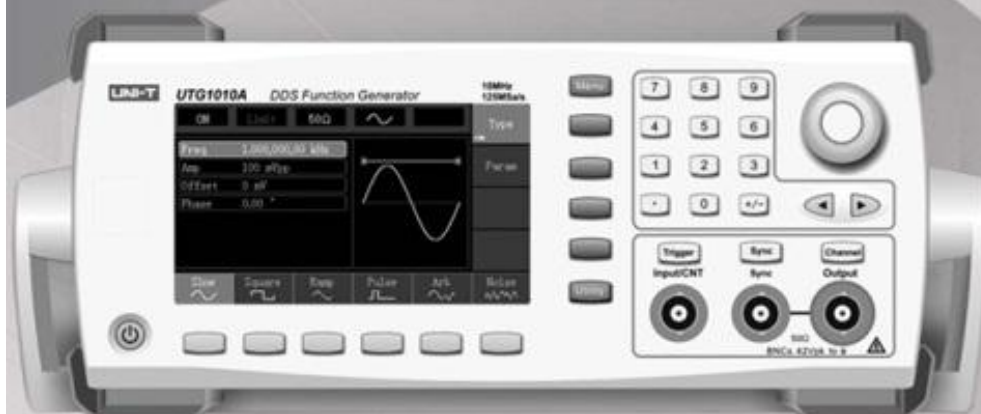

DDS Function Generator

Preface

Dear Users:

Hello! Thank you for choosing this brand new Uni-Trend device. In order to use this instrument safely and correctly, please read this manual thoroughly, especially the Safety Notes part.

After reading this manual, it is recommended to keep the manual at an easily accessible place, preferably close to the device, for future reference.

Copyright Information

UNI-T is Uni-Trend Technology (China) Limited. All rights reserved.

UNI-T products are protected by patent rights in China and other countries, including issued and pending patents.

Uni-Trend reserves the rights to any product specification and pricing changes.

Uni-Trend reserves all rights. Licensed software products are properties of Uni-Trend and its subsidiaries or suppliers, which are protected by national copyright laws and international treaty provisions. Information in this manual supercedes all previously published versions.

UNI-T is the registered trademark of Uni-Trend Technology (China) Limited.

Uni-Trend warrants that this product will be free from defects for a three-year period. If the product is re-sold, the warranty period will be from the date of the original purchase from an authorized UNI-T distributor. Probes, other accessories, and fuses are not included in this warranty.

If the product is proved to be defective within the warranty period, Uni-Trend reserves the rights to either repair the defective product without charging any parts or labor, or exchange the defected product to a working equivalent product. Replacement parts and products may be brand new, or perform at the same specifications as brand new products. All replacement parts, modules, and products are the property of Uni-Trend.

The "customer" refers to the individual or entity that is declared in the guarantee. In order to obtain the warranty service, "customer" must inform the defects within the applicable warranty period to UNI-T, and to perform appropriate arrangements for the warranty service. The customer shall be responsible for packing and shipping the defective products to the designated maintenance center of UNI-T, pay the shipping cost, and provide a copy of the purchase receipt of the original purchaser. If the product is shipped domestically to the location of the UNI-T service center, UNI-T shall pay the return shipping fee. If the product is sent to any other location, the customer shall be responsible for all shipping, duties, taxes, and any other expenses.

This warranty shall not apply to any defects or damages caused by accidental, machine parts' wear and tear, improper use, and improper or lack of maintenance. UNI-T under the provisions of this warranty has no obligation to provide the following services:

- a) Any repair damage caused by the installation, repair, or maintenance of the product by non UNI-T service representatives.
- b) Any repair damage caused by improper use or connection to an incompatible device.
- c) Any damage or malfunction caused by the use of a power source which does not conform to the requirements of this manual.

d) Any maintenance on altered or integrated products (if such alteration or integration leads to an increase in time or difficulty of product maintenance).

This warranty written by UNI-T for this product, and it is used to substitute any other expressed or implied warranties. UNI-T and its distributors do not offer any implied warranties for merchantability or applicability purposes.

For violation of this guarantee, UNI-T is responsible for the repair or replacement of defective products is the only remedy available to customers. Regardless of whether UNI-T and its distributors are informed that any indirect, special, incidental, or consequential damage may occur, the UNI-T and its distributors shall not be responsible for any of the damages.

Warranty

UNI-T warrants that the product will be free from defects for a three-year period. If the product is re-sold, the warranty period will be from the date of the original purchase from an authorized UNI-T distributor. Probes, other accessories, and fuses are not included in this warranty.

If the product is proved to be defective within the warranty period, UNI-T reserves the rights to either repair the defective product without charging of parts and labor, or exchange the defected product to a working equivalent product. Replacement parts and products may be brand new, or perform at the same specifications as brand new products. All replacement parts, modules, and products become the property of UNI-T.

The "customer" refers to the individual or entity that is declared in the guarantee. In order to obtain the warranty service, "customer" must inform the defects within the applicable warranty period to UNI-T, and to perform appropriate arrangements for the warranty service. The customer shall be responsible for packing and shipping the defective products to the designated maintenance center of UNI-T, pay the shipping cost, and provide a copy of the purchase receipt of the original purchaser. If the product is shipped domestically to the location of the UNI-T service center, UNI-T shall pay the return shipping fee. If the product is sent to any other location, the customer shall be responsible for all shipping, duties, taxes, and any other expenses.

This warranty shall not apply to any defects or damages caused by accidental, machine parts' wear and tear, improper use, and improper or lack of maintenance. UNI-T under the provisions of this warranty has no obligation to provide the following services:

- a) Any repair damage caused by the installation, repair, or maintenance of the product by non UNI-T service representatives.
- b) Any repair damage caused by improper use or connection to an incompatible device.
- c) Any damage or malfunction caused by the use of a power source which does not conform to the requirements of this manual.

d) Any maintenance on altered or integrated products (if such alteration or integration leads to an increase in time or difficulty of product maintenance).

This warranty written by UNI-T for this product, and it is used to substitute any other express or implied warranties. UNI-T and its distributors do not offer any implied warranties for merchatability or applicability purposes.

For violation of this guarantee, UNI-T is responsible for the repair or replacement of defective products is the only remedy available to customers. Regardless of whether UNI-T and its distributors are informed that any indirect, special, incidental, or consequential damage may occur, the UNI-T and its distributors shall not be responsible for any of the damages.

General Safety Overview

This instrument strictly complies with the safety requirements for electronic measuring instrument GB4793 and IEC 61010-1 safety standard during design and manufacturing. Please understand the following safety preventative measures, to avoid personal injury, and to prevent damage to the product or any connected products. To avoid possible dangers, be sure to use this product in accordance with the regulations.

Only trained personnels can perform the maintenance program.

Avoid fire and personal injury.

Use the correct power line: Only use the dedicated UNI-T power supply appointed to the local region or country for this product.

Correct Plug: Don't plug when the probe or test wire is connected to the voltage source.

Ground the product: This product is grounded through the power supply ground wire. To avoid electric shock, grounding conductors must be connected to the ground. Please be sure that the product is properly grounded before connecting to the input or output of the product.

Correct connection of oscilloscope probe: Ensure that the probe ground and ground potential are correctly connected. Do not connect ground wire to high voltage.

Check all terminal ratings: To avoid fire and the large current charge, please check all the ratings and the marks on the product. Please also refer to the product manual for details on the ratings before connecting to the product.

Do not open the case cover or front panel during operation

Only use fuses with ratings listed in the technical index

Avoid circuit exposure: Do not touch exposed connectors and components after power is connected.

Do not operate the product if you suspect it is faulty, and please contact UNI-T authorized service personnel for inspection. Any maintenance, adjustment, or replacement of parts must be performed by UNI-T authorized maintenance personnels.

Maintain proper ventilation

Please do not operate the product in humid conditions

Please do not operate in inflammable and explosive environment

Please keep the product surface clean and dry

Safety Terms and Symbols

The following terms may appear in this manual:

Warning: The conditions and behaviors may endanger life.

Note: The conditions and behaviors may cause damage to the product and other properties.

The following terms may appear on the product:

Danger: Performing this operation may cause immediate damage to the operator.

Warning: This operation may cause potential damage to the operator.

Note: This operation may cause damage to the product and devices connected to the product.

The following symbols may appear on the product:

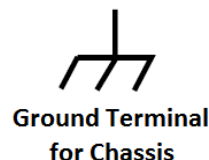
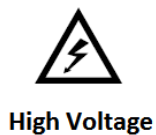

Table of Contents

Preface	1
Copyright Information.....	2
Warranty	3
General Safety Overview.....	4
Safety Terms and Symbols.....	5
Table of Contents.....	6
Chapter 1 Introduction	8
1.1 Safety Terms and Symbols	8
1.2 General Safety Overview	9
Chapter 2 Introduction	10
2.1 Main Features.....	10
2.2 Panels and Buttons.....	10
2.2.1 Front Panel.....	10
Chapter 3 Quick Start	15
3.1 General Inspection	15
3.1.1 Check for Damages Caused by Transport	15
3.1.2 Check Accessories	15
3.1.3 Machine Inspection.....	15
3.2 Handle Adjustment	15
3.3 Basic Waveform Output.....	16
3.3.1 Frequency Setting	16
3.3.2 Amplitude Setting	16
3.3.3 DC Offset Voltage Setting	17
3.3.4 Square Wave Setting.....	18
3.3.5 Pulse Wave Setting	18
3.3.6 DC Voltage Setting	19
3.3.7 Ramp Wave Setting.....	20
3.3.8 Noise Wave Setting.....	20
3.4 Frequency Measurement	21
3.5 Build-in Help System	21
Chapter 4 Advanced Applications 4.1 ROLL mode	22
4.1 Modulation Waveform Output.....	22
4.1.1 Amplitude Modulation (AM).....	22
4.1.2 Frequency Modulation (FM)	29
4.1.3 Phase Modulation (PM)	37
4.1.4 Amplitude Shift Keying (ASK)	44
4.1.5 Frequency Shift Keying (FSK)	50
4.1.6 Phase Shift Keying (PSK).....	57

4.1.7 Pulse Width Modulation (PWM).....	64
4.2 Sweep Waveform Output	71
4.2.1 Sweep Selection	71
4.2.2 Start Frequency and Stop Frequency Setting	72
4.2.3 Sweep Mode	74
4.2.4 Sweep Time.....	74
4.2.5 Trigger Source Selection	74
4.2.6 Trigger Output.....	75
4.2.7 Comprehensive Example	75
4.3 Arbitrary Wave Output	79
4.3.1 Enable Arbitrary Wave Function.....	79
4.3.2 Arbitrary Wave Selection	80
Chapter 5 Trouble Shooting.....	81
5.1 No Display On Screen (Black Screen).....	81
5.2 No Waveform Output	81
Chapter 6 Services and Supports	82
6.1 Warranty Overview	82
6.2 Contact Us.....	82
Appendix A Factory Reset State.....	83
Appendix B Technical Specifications	86
Appendix C Accessories List.....	92
Appendix D Maintenance and Cleaning	93

Chapter 1 Introduction

1.1 Safety Terms and Symbols

The following terms may appear in this manual:

Warning: The conditions and behaviors may endanger life.

Note: The conditions and behaviors may cause damage to the product and other properties.

The following terms may appear on the product:

Danger: Performing this operation may cause immediate damage to the operator.

Warning: This operation may cause potential damage to the operator.

Note: This operation may cause damage to the product and devices connected to the product.

Symbols on the product.

The following symbols may appear on the product:

 **Alternating Current**

 **Ground Terminal for Testing**

 **Ground Terminal for Chassis**

 **On/Off Button**

 **High Voltage**

 **Caution! Refer to Manual**

 **Protective Ground Terminal**

 **CE logo is a registered trademark of the European Union.**

 **C-tick logo is a registered trademark of Australia.**
N10149

 **Environmental Protection Use Period (EPUP)**

1.2 General Safety Overview

This instrument strictly complies with the GB4793 safety requirements for electrical equipment and EN61010-1/2 safety standard during design and manufacturing. It complies with the safety standards for insulated voltage standard CAT II 300V and contamination level II.

Please read the following safety preventative measures:

To avoid electric shock and fire, please use the dedicated UNI-T power supply appointed to the local region or country for this product.

This product is grounded through the power supply ground wire. To avoid electric shock, grounding conductors must be connected to the ground. Please be sure that the product is properly grounded before connecting to the input or output of the product.

To avoid personal injury and prevent damaging the product, only trained personnel can perform the maintenance program.

To avoid fire or electric shock, please notice rated operating range and product marks. Do not use the product outside the rated range.

Please check the accessories for any mechanical damage before usage.

Only use accessories that came with this product.

Please do not put metal objects into the input and output terminals of this product.

Do not operate the product if you suspect it is faulty, and please contact UNI-T authorized service personnel for inspection.

Please do not operate the product when the instrument box opens.

Please do not operate the product in humid conditions.

Please keep the product surface clean and dry.

If the equipment is used in a manner not specified by the manufacturer, the protection provided by the equipment may be impaired.

Chapter 2 Introduction

This device is economical, high-performance, multi-functional single channel waveform generators. It uses direct digital synthesis (DDS) technology to produce accurate and stable waveforms, with a resolution as low as 1 μ Hz. It can generate accurate, stable, pure and low distortion output signals, also can provide high-frequency vertical edge square waves. UTG1000's convenient interface, superior technical indexes and user-friendly graphical display style can help users to complete tasks quickly and improve work efficiency.

2.1 Main Features

- Sine wave output of 20MHz/10MHz/5MHz, full frequency range resolution is 1 μ Hz
- Square wave/pulse waveform of 5MHz, and its rising, falling, and duty cycle time are adjustable
- Using DDS implementation method, with 125M/s sampling rate and 14bits vertical resolution
- 6-bit high precision frequency counter that is TTL level compatible
- Arbitrary waveform storage of 2048 points, and it can store up to 16 groups of nonvolatile digital arbitrary waveforms
- Abundant modulation types: AM, FM, PM, ASK, FSK, PSK, PWM
- Powerful PC software
- 4.3-inch high resolution TFT liquid crystal display
- Standard configuration interface: USB Device
- Supports internal/external modulation and internal/external/manual trigger
- Supports sweep output
- Easy-to-use multifunctional knob and number keyboard

2.2 Panels and Buttons

2.2.1 Front Panel

UTG1000A series provides users with a simple, intuitive, and easy to operate front panel. The front panel is shown in figure 2-1:

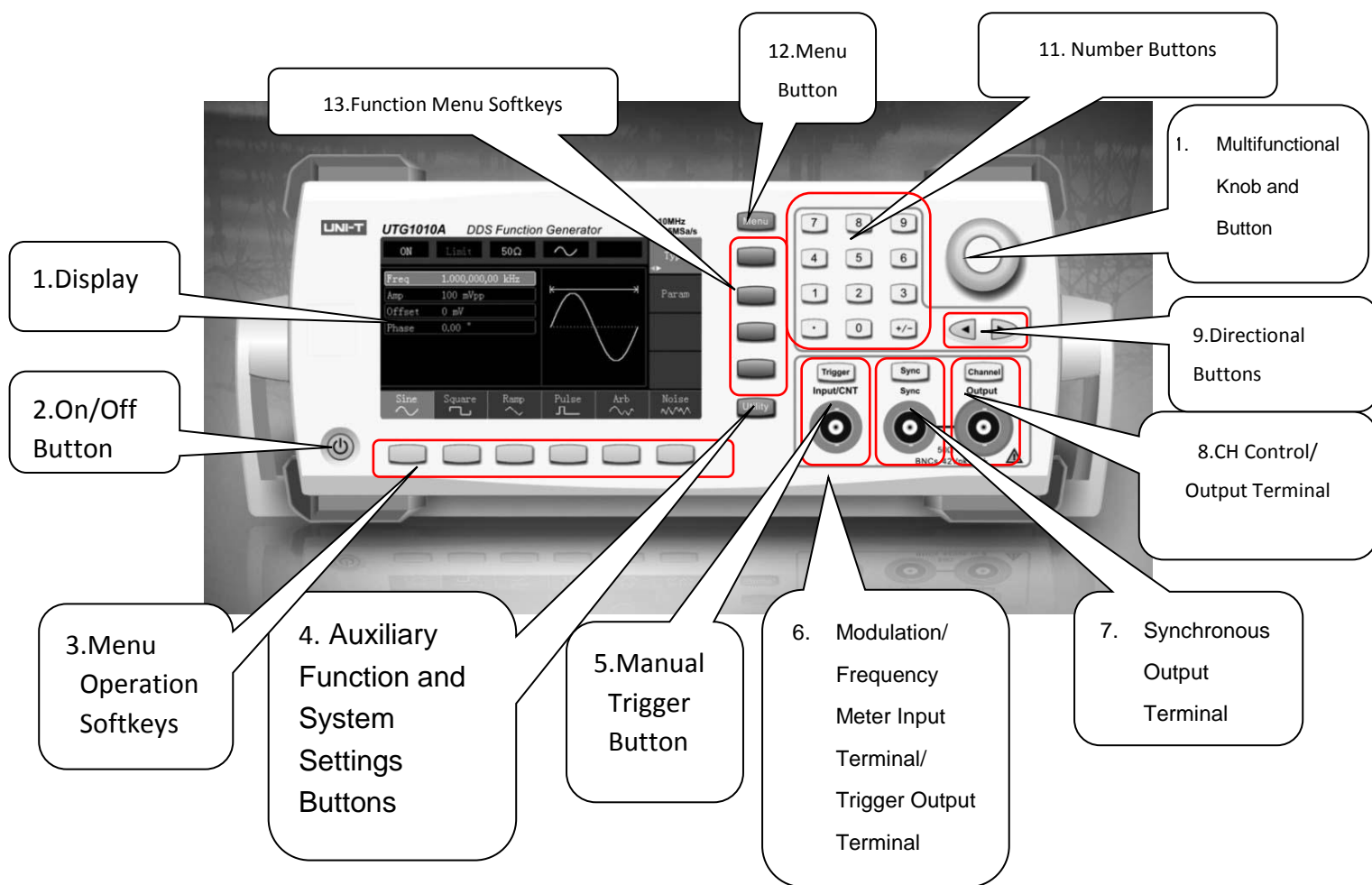

Figure 2-1

1. Display Screen

4.3-inch TFT LCD displays high-resolution output state, function menu, and other important channel information. It is designed to make human-computer interaction more convenient to improve work efficiency.

2. On/Off Button

To turn on/off the device, press this button and its backlight will turn on (orange), the display will show the function interface after the boot screen.

3. Menu Operation Softkeys

Correspondingly select or check the label contents by identifications of softkey labels (at the bottom of function interface).

4. Auxiliary Function and System Settings Button

This button includes 3 function labels: Channel settings, frequency meter, and system. A highlighted label (the midpoint of the label is gray and font is pure white) has a corresponding sub label at the bottom of the display.

5. Manual Trigger Button

Setting trigger, and carrying out manual trigger when flashing.

6. Modulation/Frequency Meter Input Terminal/Trigger Output Terminal

During AM, FM, PM or PWM signal modulation, when modulation source is external, modulation signal is input through external modulation input. When frequency meter function is on, the signal to be measured is input through this interface; when manual trigger for channel signal is enabled, manual trigger signal is output through this interface.

7. Synchronous Output Terminal

This button controls whether open synchronous output or not.

8. CH Control/ Output

Channel output can be turned on/off quickly by pressing **Channel** button, also can be set by pressing **Utility** button to pop-up the label, then pressing the **Channel** Setting softkey.

9. Direction Buttons

When setting parameters, move left and right to change number bit.

10. Multifunctional Knob and Button

Rotate the multifunctional knob to change numbers (rotate clockwise and numbers increase) or use the multifunctional knob as direction button. Press the multifunctional knob to select function, set parameters and confirm selection.

11. Number Keyboard

Number keyboard is used to enter parameter number 0 to 9, decimal point "." and symbol key "+/-". Decimal point can change units quickly.

12. Menu Button

3 function labels will pop up by pressing the menu button: Waveform, Modulation, and Sweep. Press the corresponding menu function softkey to get its function.

13. Functional Menu Softkeys

To select function menu quickly

The rear panel is shown in figure 2-2:



Figure 2-2

1. USB Interface

PC software is connected through this USB interface.

2. Heat Dissipation Holes

To ensure this instrument dissipate heat well, please do not block these holes.

3. Insurance Pipe

When AC input current is more than 2A, the fuse will cut off the AC input to protect the device.

4. Main Power Switch

Press down on "I" to power the instrument, and press down on "O" to cut off AC input.

5. AC Power Input Terminal

This device supports AC power from 100V to 240V, 45Hz to 440 Hz, and power fused is 250V, T2 A.

Function interface is shown in figure 2-3:

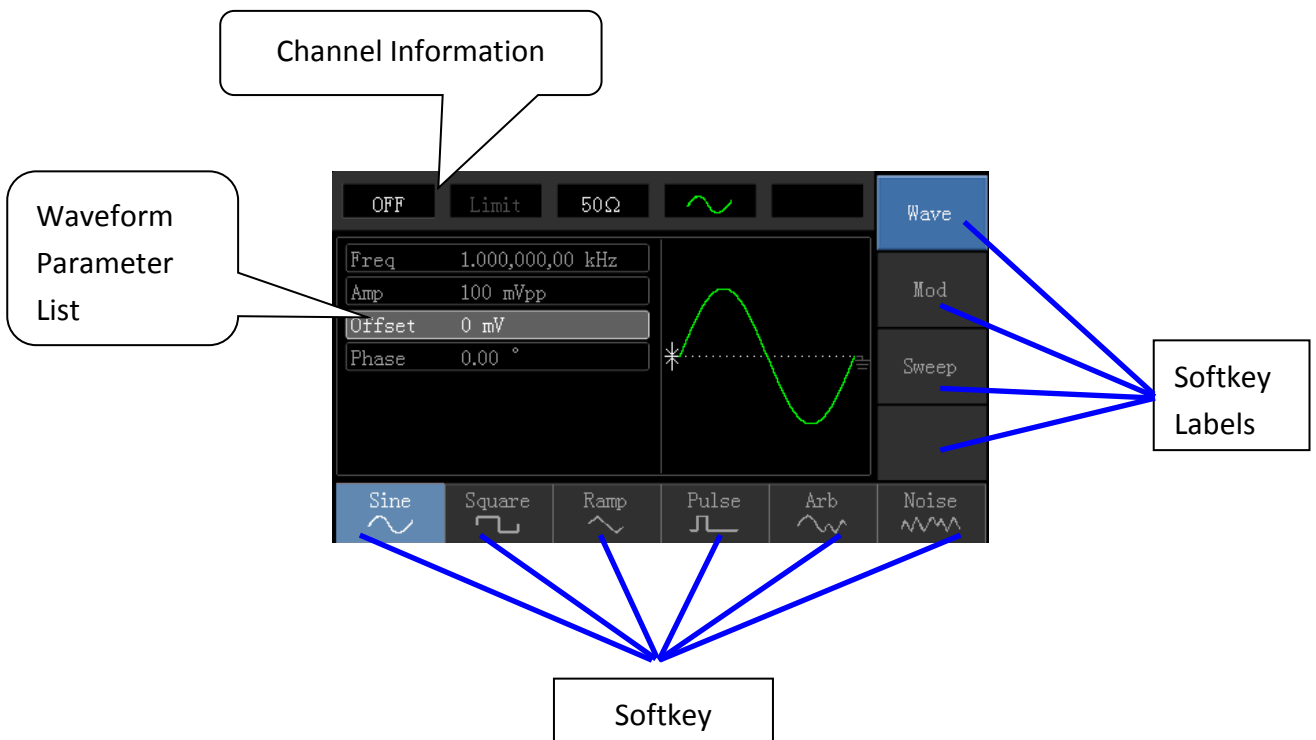

Figure 2-3

Detailed Description:

- ✧ Channel information: 1) “ON/OFF” on the left is channel open information. 2) There is a “Limit” logo indicates output range limit where white is valid and grey is invalid. The matched impedance of output terminal (1Ω to 1KΩ adjustable, or high resistance, factory default is 50Ω). 3) The right side is the current valid waveform.
- ✧ Softkey labels: Softkey labels are used for identifying menu softkey functions and menu operation softkey functions.
 - 1) Labels on the right of screen: Highlighted display indicates that the label is selected. If not, press corresponding softkey to select.
 - 2) Labels at the bottom of screen: Sub label contents belongs to the next category of Type label. Press corresponding button to select sub labels.
- ✧ Waveform Parameter List: Displays parameters of current waveform in a list.
- ✧ Waveform Display Area: Displays current channel’s waveform.

Chapter 3 Quick Start

3.1 General Inspection

It is recommended to follow the steps below to check the instrument before using this device for the first time.

3.1.1 Check for Damages Caused by Transport

If the packaging carton or the foam plastic cushions are severely damaged, please contact the UNI-T distributor of this product immediately.

If the instrument is damaged by transport, please keep the package and contact the transport department and the UNI-T distributor, the distributor will arrange for repairment or replacement.

3.1.2 Check Accessories

UTG1000 accessories are: Power cord, USB data cable, BNC cable (1 meter), and user CD.

If any of the accessories are missing or damaged, please contact UNI-T or local distributors of this product.

3.1.3 Machine Inspection

If the instrument appears to be damaged, not working properly, or has failed the functionality test, please contact UNI-T or local distributors of this product.

3.2 Handle Adjustment

UTG1000 series handle can be adjusted freely. If the handle position needs to be changed, please hold the handle on both sides and pull out, then rotate the handle to the desired position, as shown in figure

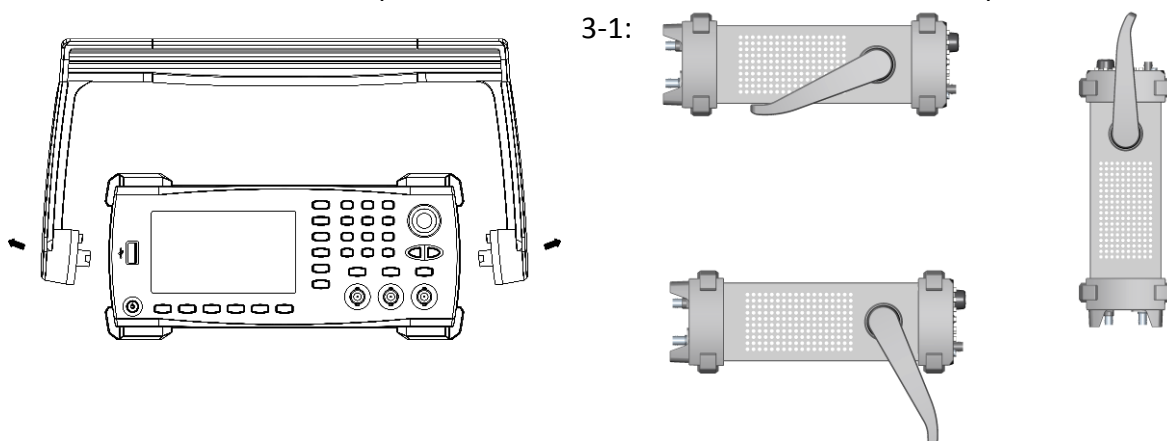

Figure 3-1

3.3 Basic Waveform Output

3.3.1 Frequency Setting

Default waveform: A sine wave of 1kHz frequency and 100mV amplitude (with 50Ω termination).

Steps for changing the frequency to 2.5MHz are shown as following:

- Press **Menu**→**Waveform**→**Parameter**→**Frequency** in turn to frequency setting mode. Set parameters by pressing **Frequency** softkey to change frequency and period.
- Use number keyboard to input the required number of 2.5.

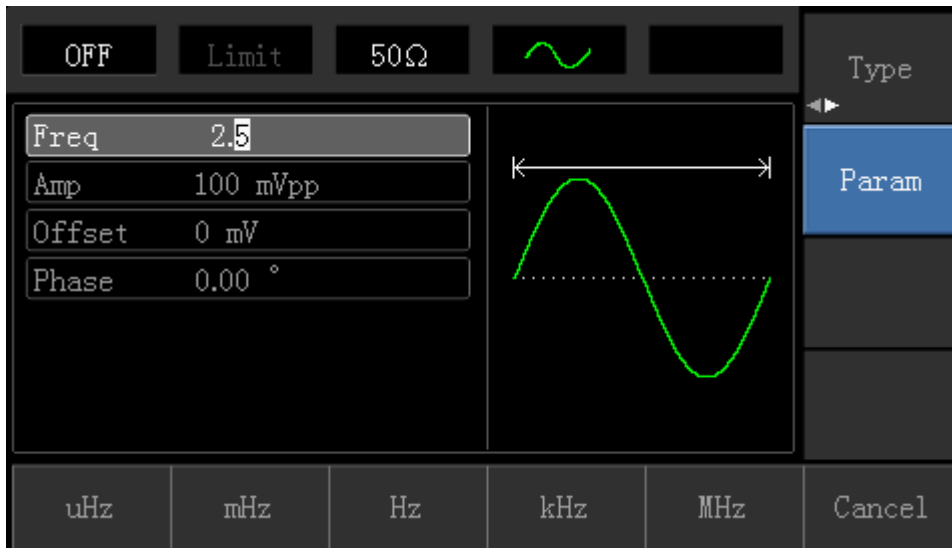

- Select corresponding unit MHz.

3.3.2 Amplitude Setting

Default waveform: A sine wave of 100mV peak-peak value with 50Ω termination.

Steps for changing the amplitude to 300mV are shown as following:

- Press **Menu**→**Waveform**→**Parameter**→**Amplitude** in turn. Press **Amplitude** softkey again can switch between Vpp, Vrms, and dBm.
- Use number keys to input 300.

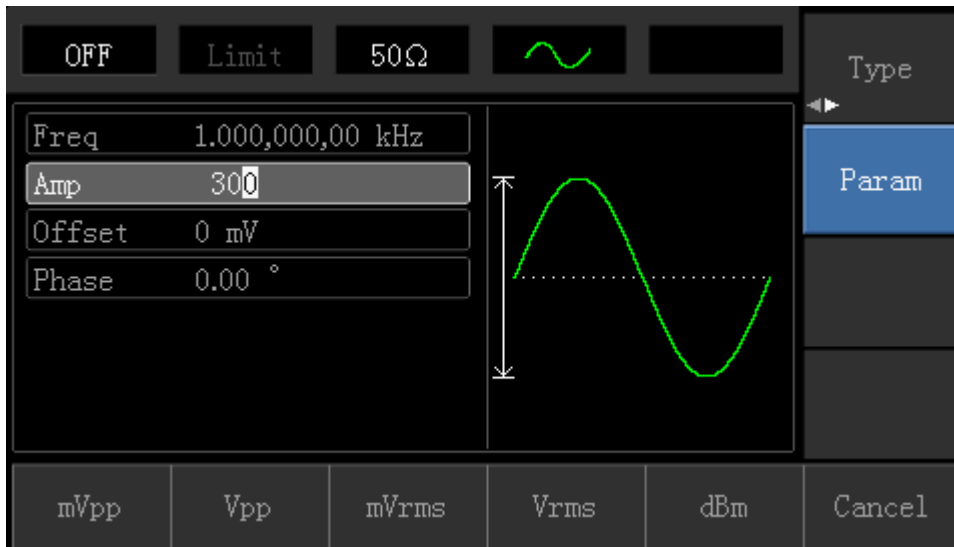

3. Select required unit: Press unit softkey **Vpp**.

Note: This parameter can be set by multifunctional knob and direction buttons.

3.3.3 DC Offset Voltage Setting

The default waveform is a sine wave with 0V DC offset voltage (with 50Ω termination). Steps for changing DC offset voltage to -150mV are shown as following:

1. Press **Menu** → **Waveform** → **Parameter** → **Offset** to enter parameter setting.
2. Use number keys to input the required number of -150.

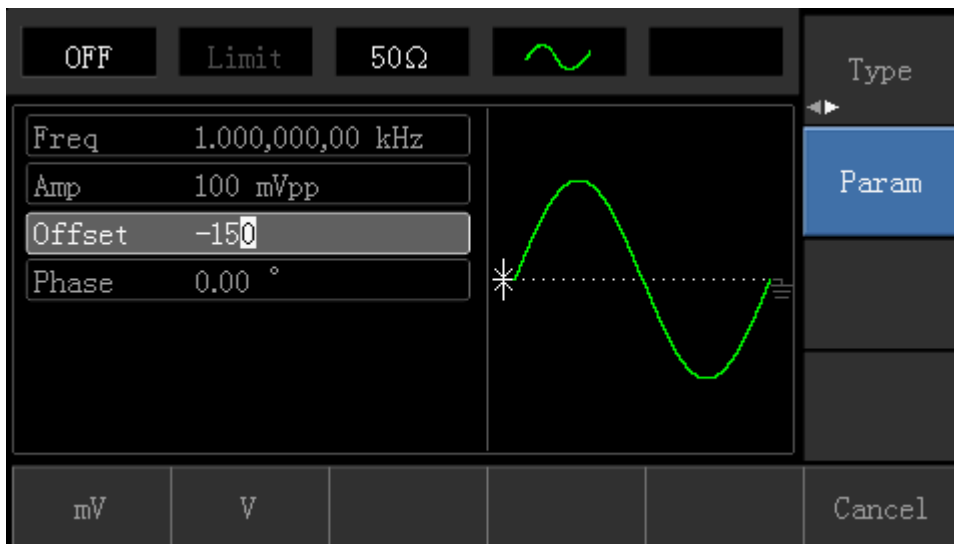

3. Select corresponding unit **mV**.

Note: This parameter can be set by multifunctional knob and direction buttons.

3.3.4 Square Wave Setting

Press **Menu** → **Waveform** → **Type** → **Squarewave** → **Parameter** in turn (press **Type** softkey to select only when **Type** label is not highlighted). If parameter needs to be set, press corresponding softkey to enter required numerical value and select the unit.

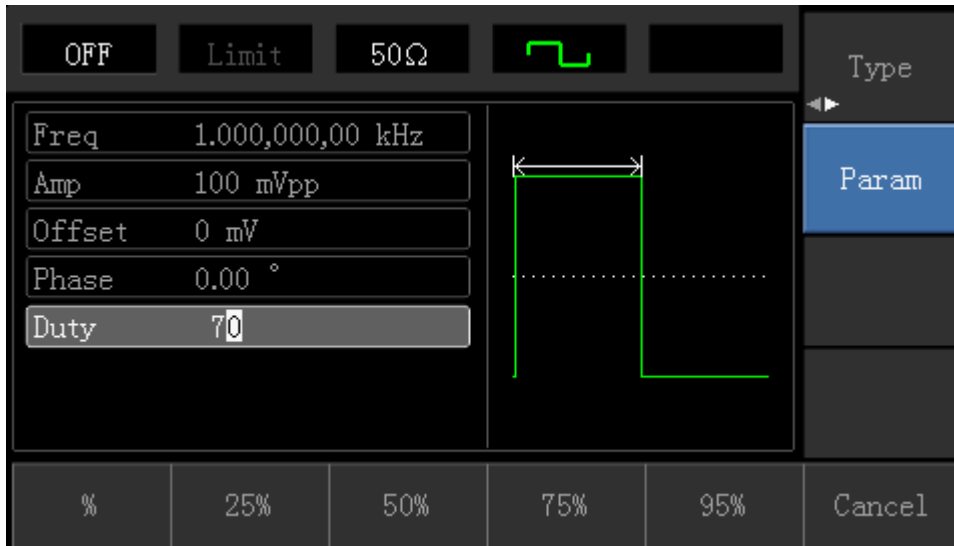

Note: This parameter can be set by multifunctional knob and direction buttons.

3.3.5 Pulse Wave Setting

Default duty cycle of pulse wave is 50% and rising/falling edge time is 1us. Steps for setting square wave with 2ms period, 1.5Vpp amplitude, 0V DC offset and 25% duty cycle (limited by the minimum pulse width specification 80ns), 200us rising time and 200us falling time are seen as following:

Press **Menu** → **Waveform** → **Type** → **PulseWave** → **Parameter** in turn, then press **Frequency** softkey to switch to Period. Enter required number value and select the unit. When entering duty cycle value, there is a quick label at the bottom of display, and select 25%.

If need to set falling edge time, press **Parameter** softkey or rotate multifunctional knob to the right to enter sub label, then press **Falling Edge** softkey to enter required number and select unit.

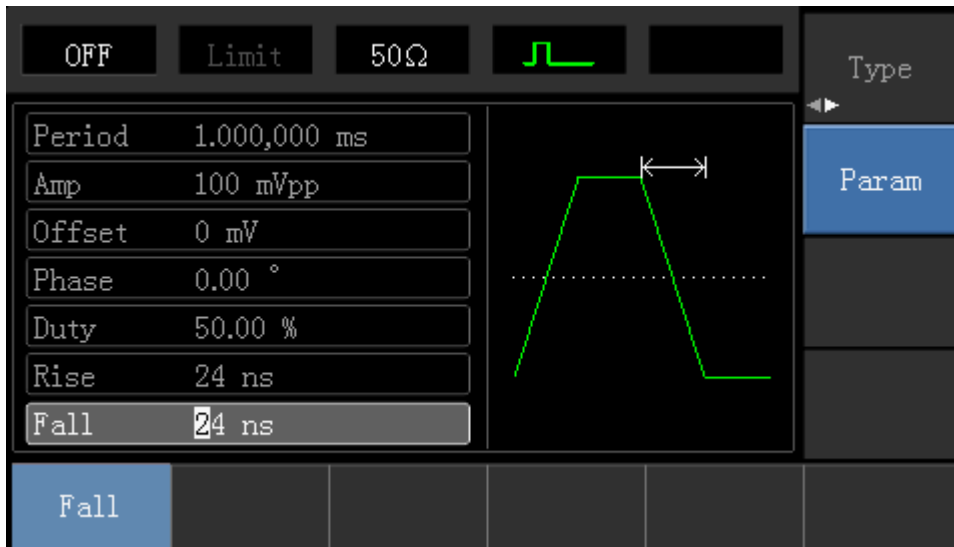

Note: This parameter can be set by multifunctional knob and direction buttons.

3.3.6 DC Voltage Setting

Actually, DC voltage output is the setting of DC offset. Steps for changing DC offset voltage to 3V are seen as following:

1. Press **Menu** → **Waveform** → **Type** → **DC** in turn to enter parameter setting mode.
2. Use number keyboard to input the required number of 3.

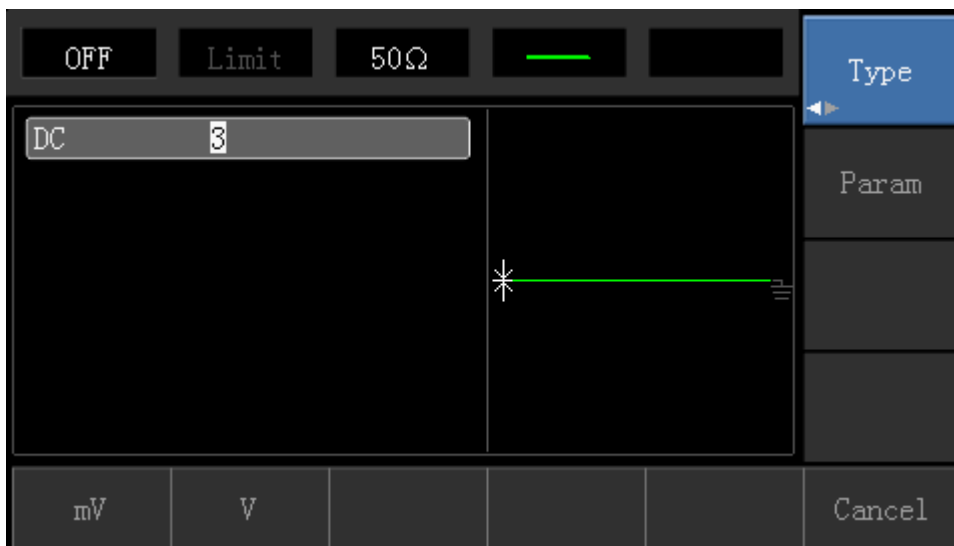

3. Select required unit V

Note: This parameter can be set by multifunctional knob and direction buttons.

3.3.7 Ramp Wave Setting

Default symmetry degree of ramp wave is 100%. Steps for setting triangular wave with 10kHz frequency, 2V amplitude, 0V DC offset and 50% duty cycle are seen as following:

Press **Menu**→**Waveform**→**Type**→**RampWave**→**Parameter** in turn to enter parameter setting mode. Select parameter to enter edit mode, then input required numbers and select unit. Note: When enter symmetry degree value, there is a **50%** label at the bottom of display, press corresponding softkey or use number keyboard.

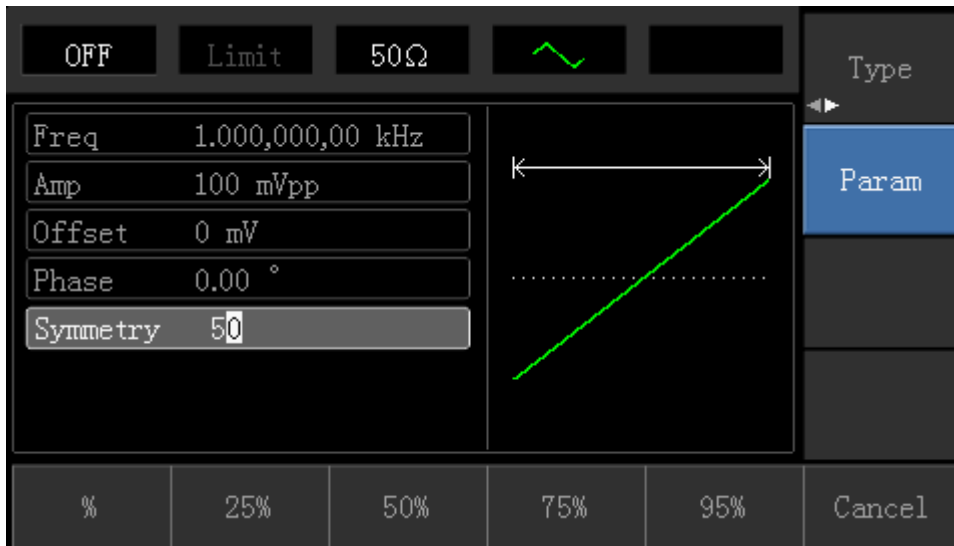

Note: This parameter can be set by multifunctional knob and direction buttons.

3.3.8 Noise Wave Setting

Default Quasi Gauss noise amplitude is 100mVpp and DC offset is 0mV. Steps for setting Quasi Gauss noise with 300mVpp amplitude and 1V DC offset are shown as following:

Press **Menu**→**Waveform**→**Type**→**Noise**→**Parameter** in turn to enter parameter editing mode. After setting, enter required number and unit.

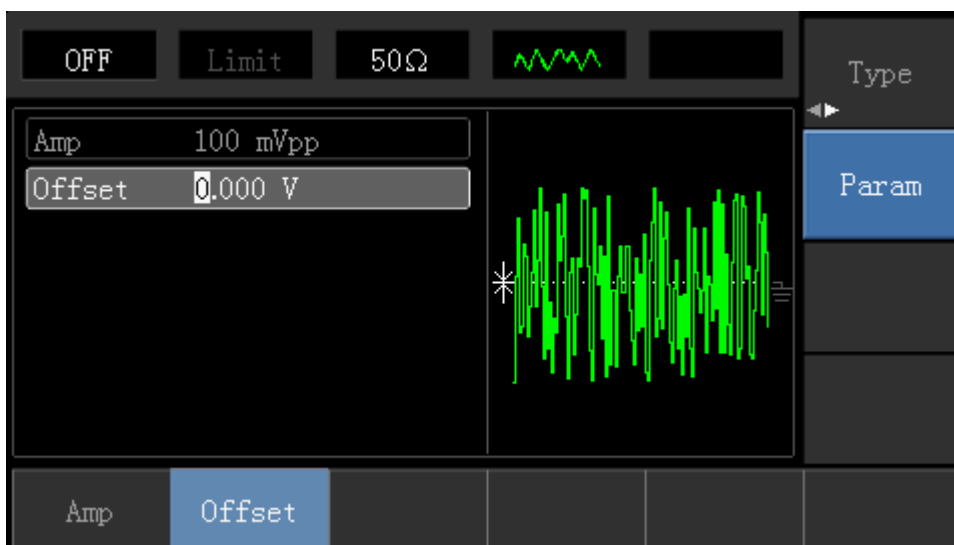

Note: This parameter can be set by multifunctional knob and direction buttons.

3.4 Frequency Measurement

This device is suitable for measuring frequency and duty cycle of TTL compatible signals, with frequency range of 1Hz to 100MHz. The frequency meter takes signal through the input interface (Input/CNT terminal). Press **Utility** then **Counter** to collect Frequency, Period, and Duty Cycle values from input signal. Note: When there is no signal input, frequency meter parameter list always shows last measurement value. Frequency meter will refresh only when new TTL compatible signal is present at the Input/CNT terminal.



3.5 Build-in Help System

The build-in help system provides relevant information for any button or menu softkey. You also can use help topic list to get help. Operations for buttons help information are shown as following: Long press any softkey or button to display relevant information. If the content is more than 1 screen size, use **▶** softkey or multifunctional knob to display the next screen. Press “Return” to exit.

Note!

The built-in help system provides simplified Chinese and English languages. All information, context help and help topic are displayed in selected language. Language setting: **Utility** → **System** → **Language**.

Chapter 4 Advanced Applications 4.1 ROLL mode

4.1 Modulation Waveform Output

4.1.1 Amplitude Modulation (AM)

Press **Menu** → **Modulation** → **Type** → **Amplitude Modulation** in turn to start the AM function. Then the modulated waveform will output with modulation waveform and carrier wave set.

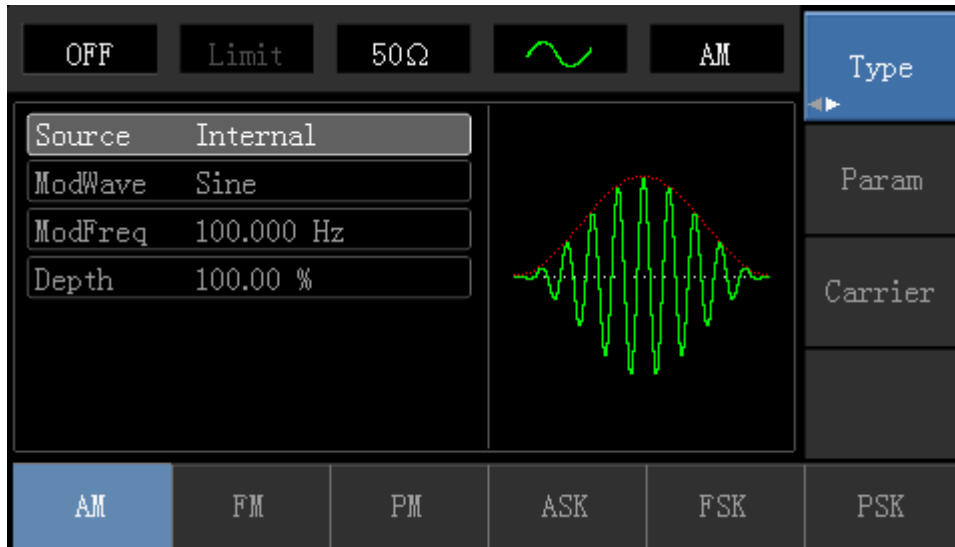

Carrier Waveform Selection

AM carrier waveform can be: sine wave, square wave, ramp wave or arbitrary wave (except DC), and the default is sine wave. After selecting AM modulation, press Carrier Wave Parameter softkey to enter carrier waveform selection interface.

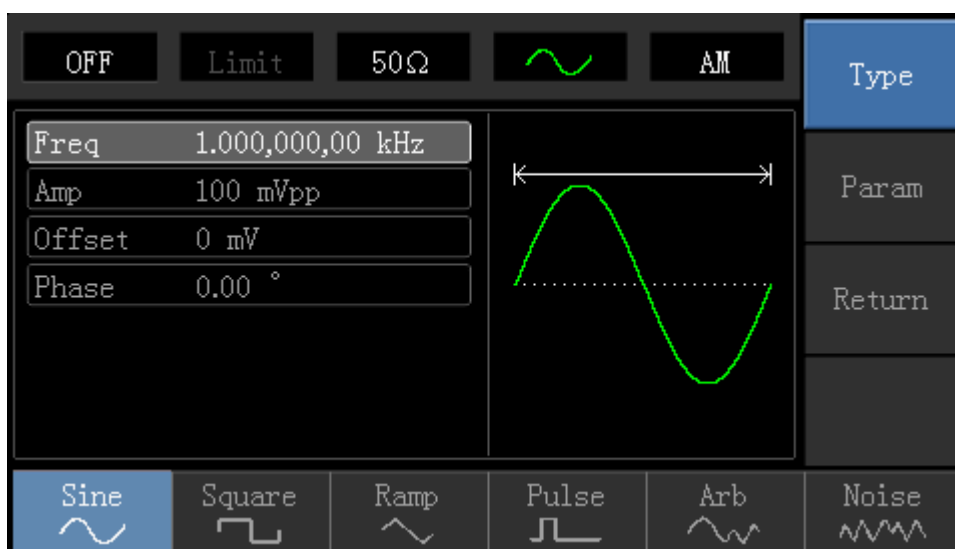

Carrier Wave Frequency Setting

Settable carrier wave frequency range is different for different carrier waveforms. Default frequency of all carrier wave is 1kHz. The frequency setting range of each carrier wave can be seen in the following table:

Carrier Wave	Frequency			
	UTG1010A		UTG1005A	
	Minimum Value	Maximum Value	Minimum Value	Maximum Value
Sine Wave	1μHz	10MHz	1μHz	5MHz
Square wave	1μHz	5MHz	1μHz	5MHz
Ramp Wave	1μHz	400kHz	1μHz	400KHz
Arbitrary Wave	1μHz	2MHz	1μHz	1MHz

If need to set carrier frequency, please press **Parameter** → **Frequency** softkey, then enter required numerical value, and select unit after selecting carrier waveform.

Modulation Source Selection

This device can select internal modulation source or external modulation source. After enabling AM function, the default modulation source is internal. If need to change press

Parameter → **ModulationSource** → **External** in turn.

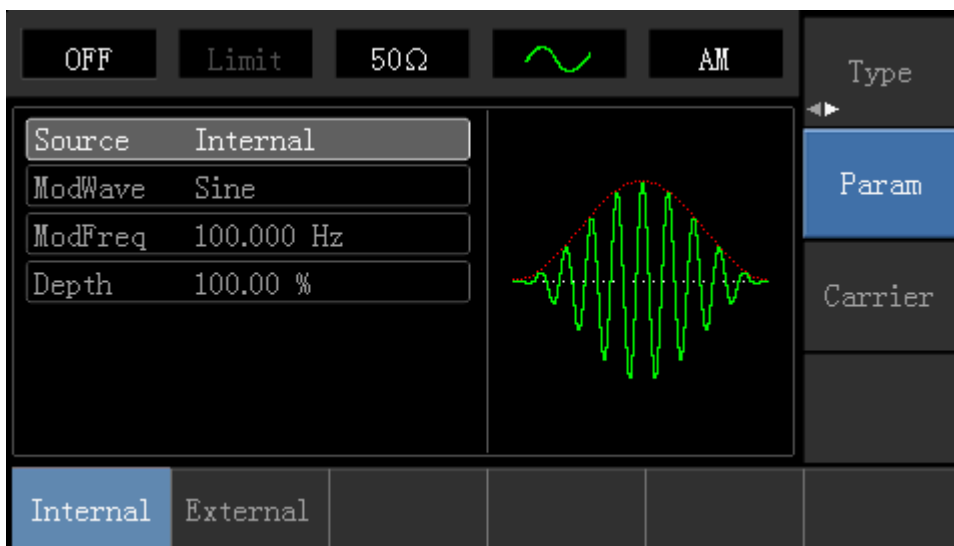

1) Internal Source

When modulation source is internal, modulation wave can be: sine wave, square wave, rising ramp wave, falling ramp wave, arbitrary wave and noise. After enabling AM function, the default of modulation wave is sine wave. If need to change it, press **Carrier Wave** → **Parameter** → **Type** in turn.

- Square wave: duty cycle is 50%
- Rising Ramp Wave: symmetry degree is 100%
- Falling Ramp Wave: symmetry degree is 0%
 - Arbitrary Wave: when arbitrary wave is modulated waveform, DDS function generator limits arbitrary wave length as 1kpts in the way of random selection
- Noise: White Gauss noise

2) External Source

When modulation source is external, parameter list will hide the modulation wave option and modulation frequency option, and carrier waveform will be modulated by an external waveform. AM modulation depth is controlled by $\pm 5V$ signal level of external modulation input terminal. For example, if modulation depth value is set to 100%, AM output amplitude is the maximum when external modulation signal is +5V, AM output amplitude is the minimum when external modulation signal is -5V.

Modulation Shape Frequency Setting

When modulation source is internal, frequency of modulation shape can be modulated. After enabling AM function, range of modulation wave frequency is 2mHz~50kHz (default is 100Hz). Press **Parameter** → **Modulation Frequency** to change. When modulation source is external, parameter list will hide the modulation shape option and modulation frequency option, and carrier waveform will be modulated by an external waveform. The range of modulation signal input from external is 0Hz~ 20Hz.

Modulation Depth Setting

Modulation depth indicates the extent of amplitude variation and is expressed as percentage. Suitable setting range of AM modulation depth is 0% to 120%, and the default is 100%. When modulation depth is set to 0%, the constant amplitude (a half of the carrier wave amplitude that has been set) is output. Output amplitude changes as modulation waveform changes when modulation depth is set to 100%. The instrument output a peak-peak voltage less than $\pm 5V$ (is connected with 50 Ω terminal) when modulation depth is more than 100%. If need to change, press **Parameter** → **Modulation Depth** in amplitude function interface. When modulation source is external, output amplitude of the instrument is controlled by $\pm 5V$ signal level of external modulation input terminal (Input/CNT probe) in rear panel. For example, if modulation depth value in parameter list has been set to 100%, AM output amplitude is the maximum when external modulation signal is +5V, AM output amplitude is the minimum when external modulation signal is -5V.

Comprehensive Example

Firstly, make the instrument work in amplitude modulation (AM) mode, then set a sine wave with 200Hz from the internal of the instrument as a modulation signal and a square wave with frequency of 10kHz, amplitude of 200mVpp and duty cycle of 45% as a carrier wave signal. Finally, set modulation depth to 80%. Specific steps are seen as following:

1) Enable Amplitude Modulation (AM) Function

Press **Menu** → **Modulation** → **Type** → **Amplitude Modulation** in turn.

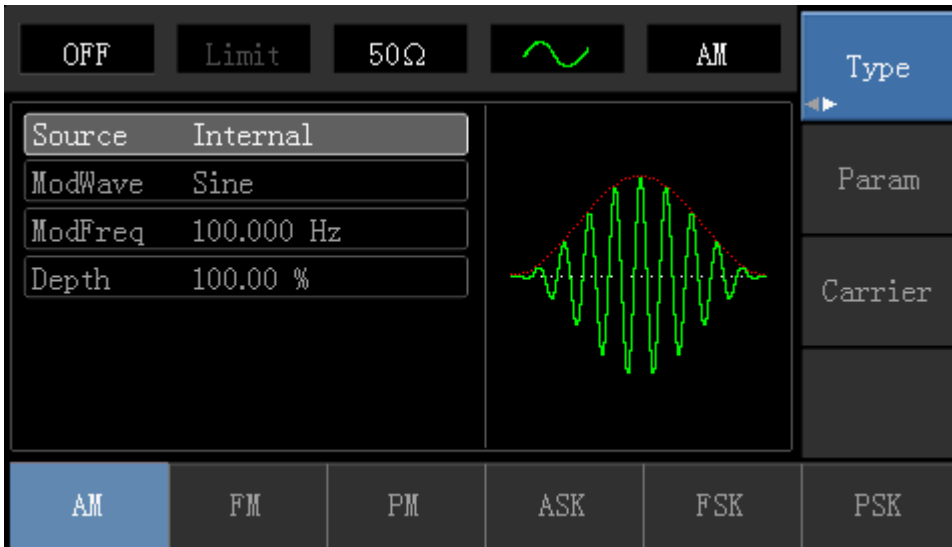

2) Set Modulation Signal Parameter

After enabling the AM function, press **Parameter** softkey and the interface will appear as following:

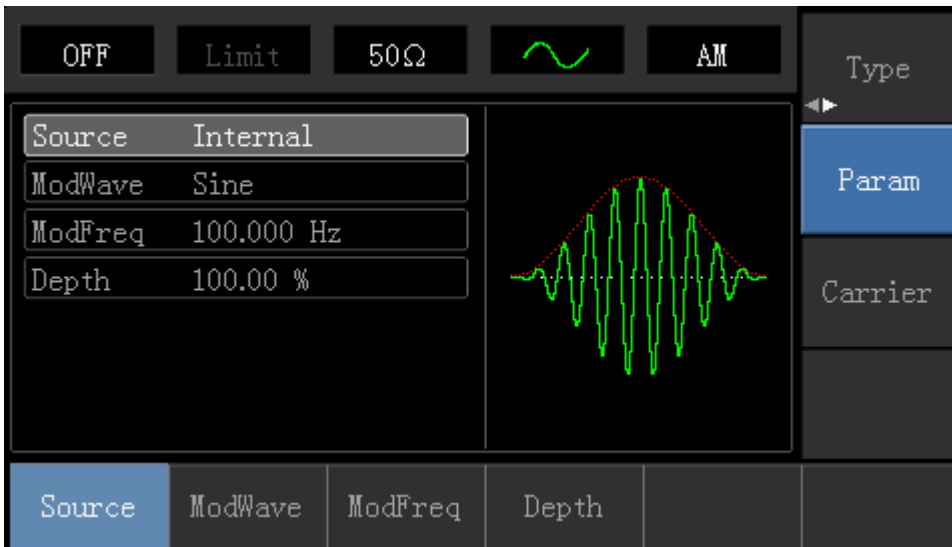

Press corresponding softkey, then enter required numerical value, and select the unit.

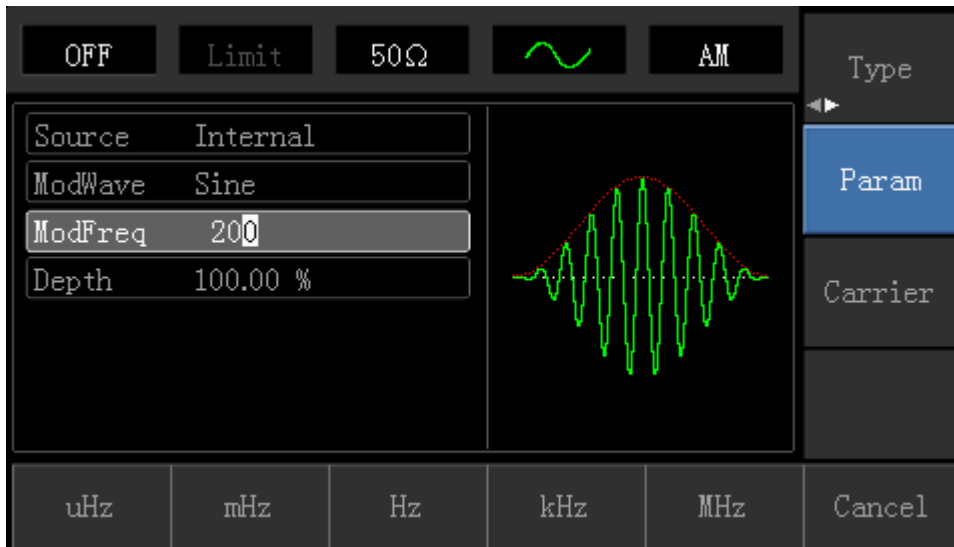

3) Set Carrier Wave Signal Parameter

Press **Carrier Wave Parameter** → **Type** → **Square Wave** in turn to select square wave as carrier wave signal.

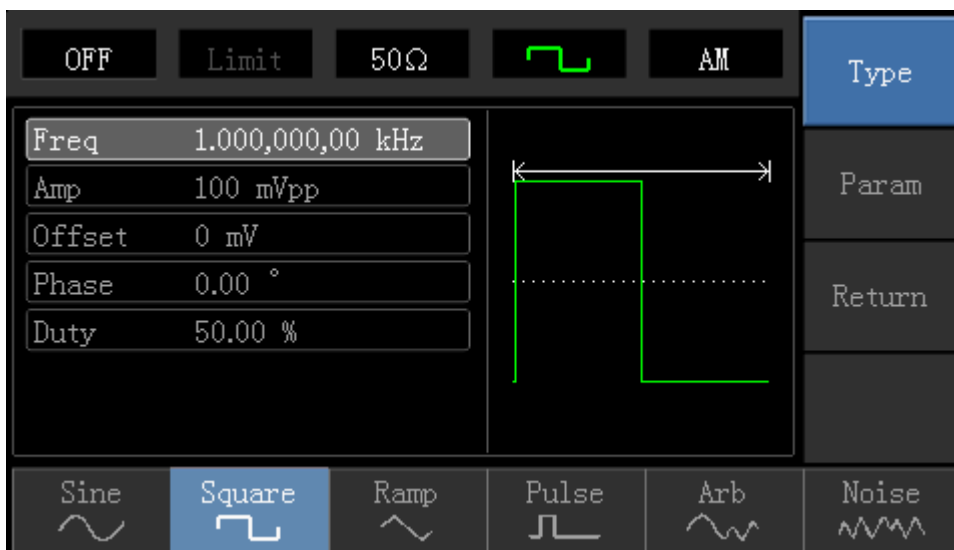

Press **Parameter** softkey again, and the interface will pop up as following:

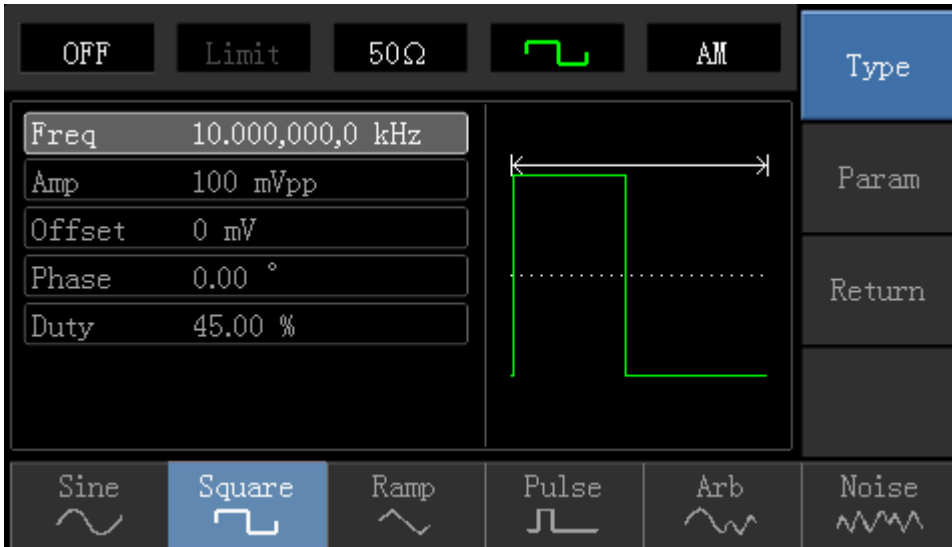

Press corresponding softkey, then enter required numerical value, and select the unit.

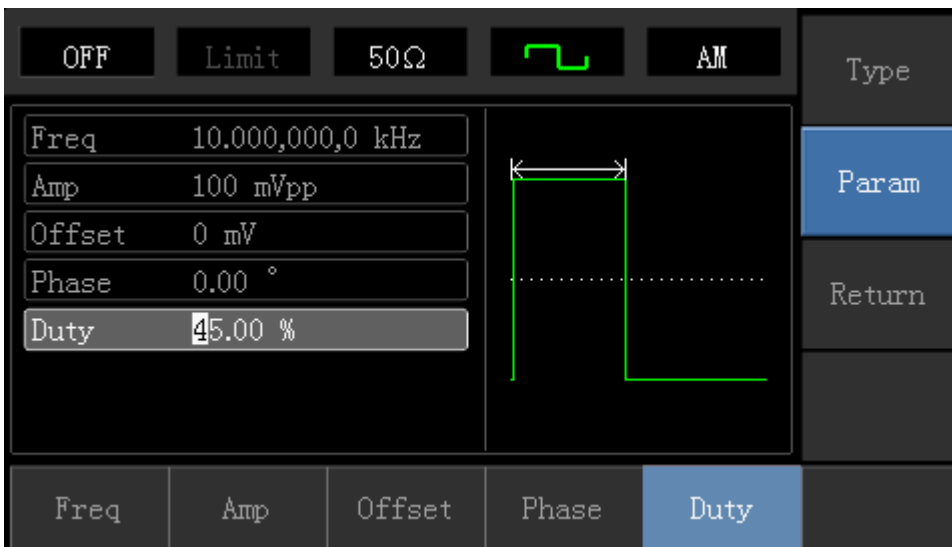

4) Set Modulation Depth

After setting carrier wave parameter, press Return softkey to back to the following interface for setting modulation depth.

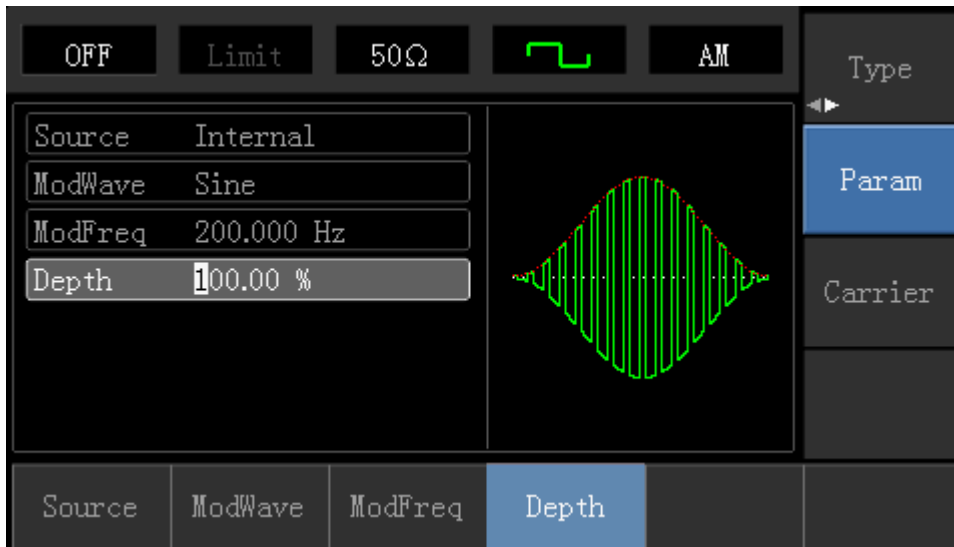

Press **Parameter** → **Modulation Degree** softkey again, then enter number 80 and press **%** softkey with number keyboard for setting modulation depth.

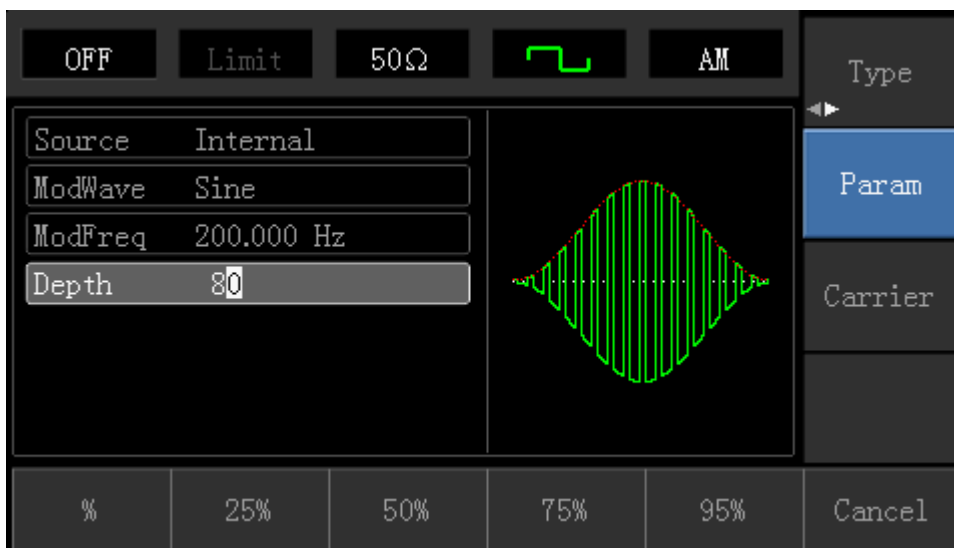

5) Enable Channel Output

Press **Channel** button start channel output quickly. Or enable output by pressing **Channel Setup** softkey after pressing **Utility** button and popping up labels. After channel output is opened, backlight of **Channel** button is on, and on the right side of channel information label, the font “OFF” changes to “ON”, meaning open channel output.

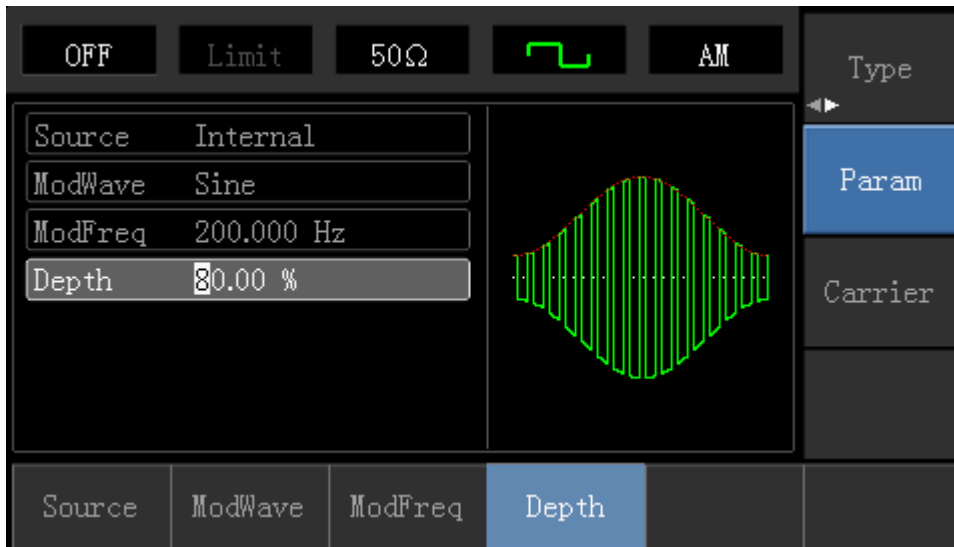

The shape of AM modulation waveform checked through oscilloscope is shown as following:

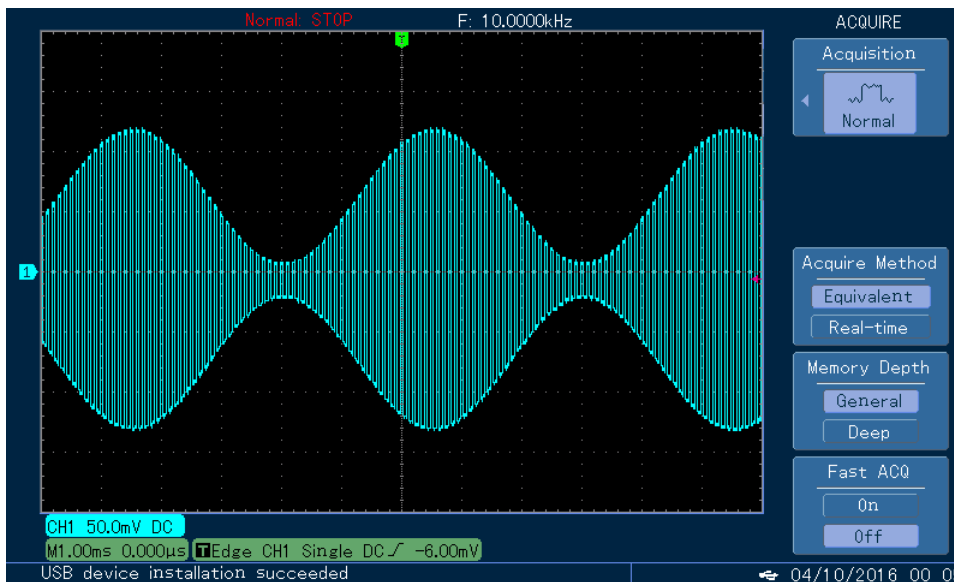

4.1.2 Frequency Modulation (FM)

In frequency modulation, modulated waveform is usually composed of carrier wave and modulation shape. Carrier wave frequency will change as the amplitude of modulation shape changes.

Press **Menu** → **Modulation** → **Type** → **Frequency Modulation** in turn to start the FM function. The device will output modulated waveform with modulation waveform and carrier wave set currently.

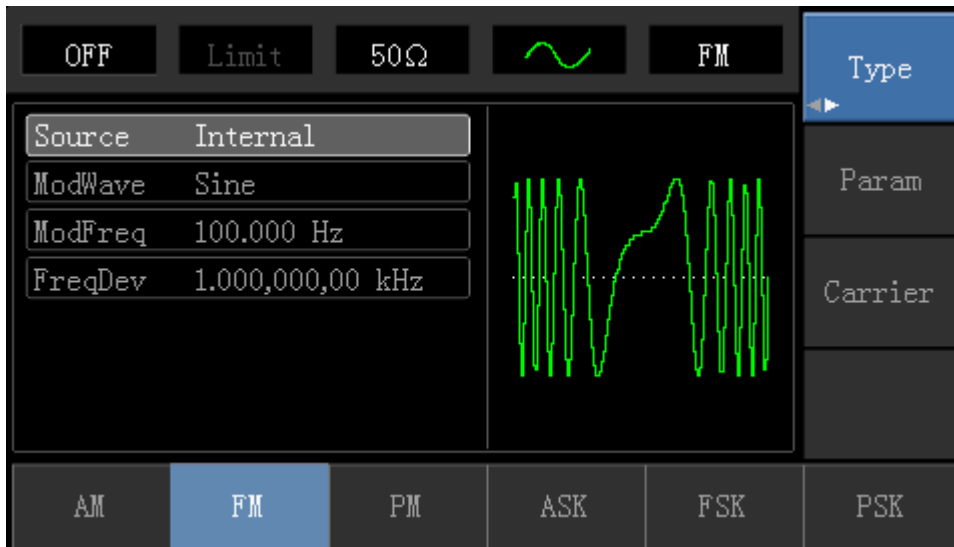

Carrier Wave Waveform Selection

FM carrier waveform can be: Sine wave, square wave, ramp wave, pulse wave, arbitrary wave (except DC) and noise (the default is sine wave). After selecting FM modulation, press **Carrier Wave Parameter** softkey to enter carrier waveform selection interface.

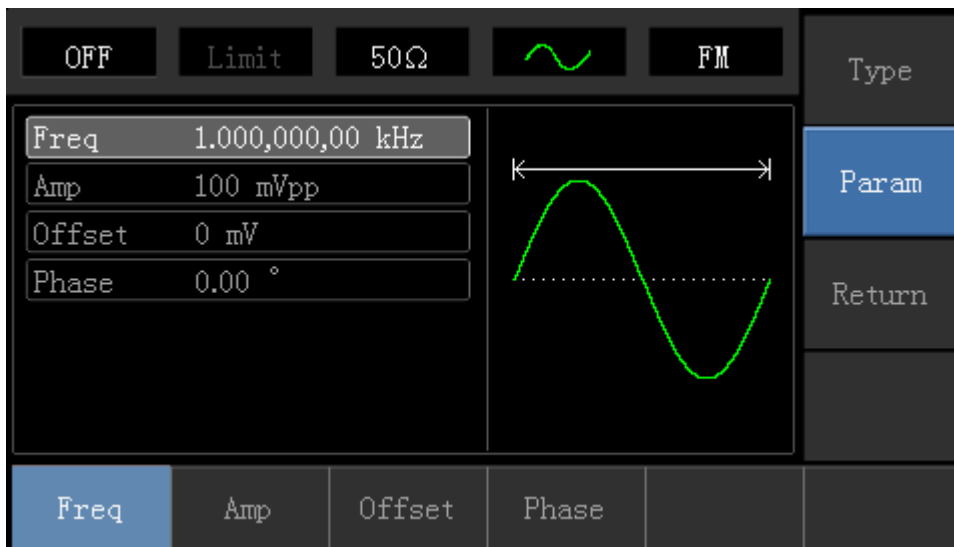

Carrier Wave Frequency Setting

Settable carrier wave frequency range is different of different carrier waveform. Default frequency of all carrier wave is 1kHz. The frequency setting range of each carrier wave can be seen in the following table:

Carrier Waveform	Frequency			
	UTG1010A		UTG1005A	
	Minimum	Maximum	Minimum	Maximum

Sine Wave	1μHz	10MHz	1μHz	5MHz
Square wave	1μHz	5MHz	1μHz	5MHz
Ramp Wave	1μHz	400kHz	1μHz	400KHz
Arbitrary Wave	1μHz	2MHz	1μHz	1MHz

Press **Parameter** → **Frequency** softkey in turn to set carrier wave frequency, then enter required numerical value, and select unit.

Modulation Source Selection

This device can select internal modulation source or external modulation source. After enabling FM function, the default of modulation source is internal. If need to change, press

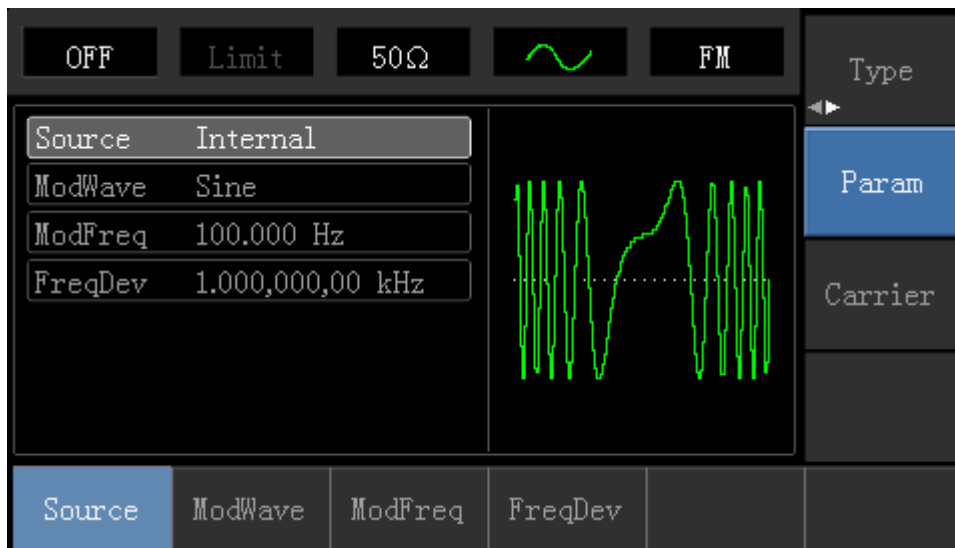

1) Internal Source

When modulation source is internal, modulation wave can be: sine wave, square wave, rising ramp wave, falling ramp wave, arbitrary wave and noise. After enabling FM function, the default of modulation wave is sine wave. If need to change, press **Carrier Wave** → **Parameter** → **Type** in turn.

- Square wave: duty cycle is 50%
- Lead Ramp Wave: symmetry degree is 100%
- Tail Ramp Wave: symmetry degree is 0%
- Arbitrary Wave: Arbitrary wave length limit is 1kpts
- Noise: White Gauss noise

2) External Source

When modulation source is external, carrier waveform will be modulated by an external waveform. FM frequency deviation is controlled by ±5V signal level of external modulation input terminal on front

panel. In positive signal level, FM output frequency is more than carrier wave frequency, while in negative signal level, FM output frequency is less than carrier wave frequency. Low external signal level has small deviation. For example, if the frequency offset is set to 1kHz and the external modulation signal is +5V, FM output frequency will be the current carrier frequency plus 1kHz. When the external modulation signal is -5V, FM output frequency will be the current carrier frequency minus 1kHz.

Modulation Shape Frequency Setting

When modulation source is internal, frequency of modulation shape can be modulated. After enabling FM function, the default of modulation shape frequency is 100Hz. If need to change, press **Carrier** **Wave Parameter** → **Modulation Frequency** in turn, and the modulation frequency range is 2mHz to 50kHz. When modulation source is external, parameter list will hide the modulation shape option and modulation frequency option, and carrier waveform will be modulated by an external waveform. The range of modulation signal input from external is 0Hz to 20Hz.

Frequency Deviation Setting

Frequency deviation represents the difference between frequency of the FM modulated waveform and the carrier frequency. Settable range of FM frequency deviation is from 1μHz to the maximum of current carrier wave frequency, and the default value is 1kHz. If need to change, press **Parameter** → **Frequency Deviation** in turn.

- Frequency deviation is less than carrier wave frequency. If frequency deviation value is set higher than carrier wave frequency, the device will automatically set the offset value to the carrier frequency's maximum allowable frequency.
- Sum of frequency deviation and carrier wave frequency is less than the allowed maximal frequency of current carrier wave. If the frequency deviation value is set to an invalid value, the device will automatically set the offset value to the carrier frequency's maximum allowable frequency.

Comprehensive Example:

Make the instrument work in frequency modulation (FM) mode, then set a sine wave with 2kHz from the internal of the instrument as a modulation signal and a square wave with frequency of 10kHz and amplitude of 100mVpp as a carrier wave signal. Finally, set frequency deviation to 5kHz. Specific steps are seen as following:

1) Enable Frequency Modulation (FM) Function

Press **Menu** → **Modulation** → **Type** → **Frequency Modulation** in turn to start the FM function.

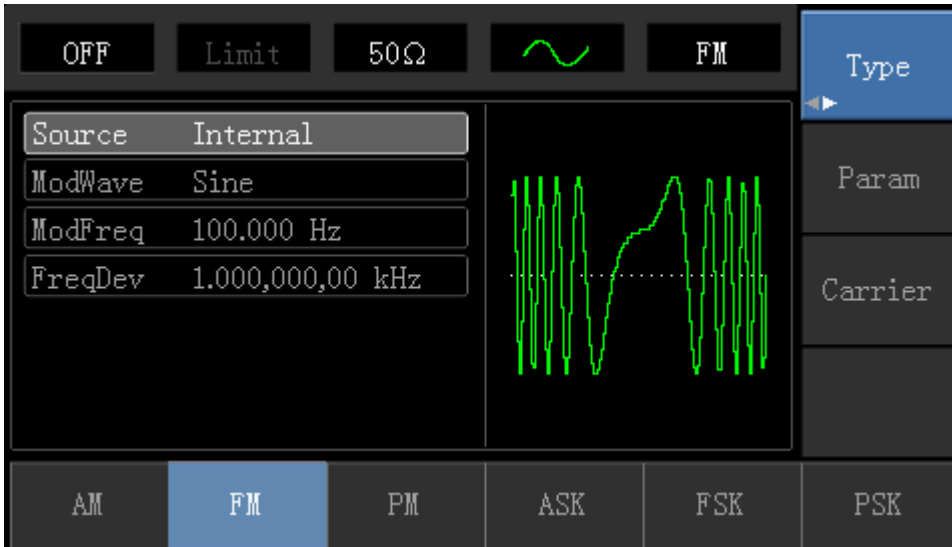

2) Set Modulation Signal Parameter

Press **Parameter** softkey. Then the interface will show as following:

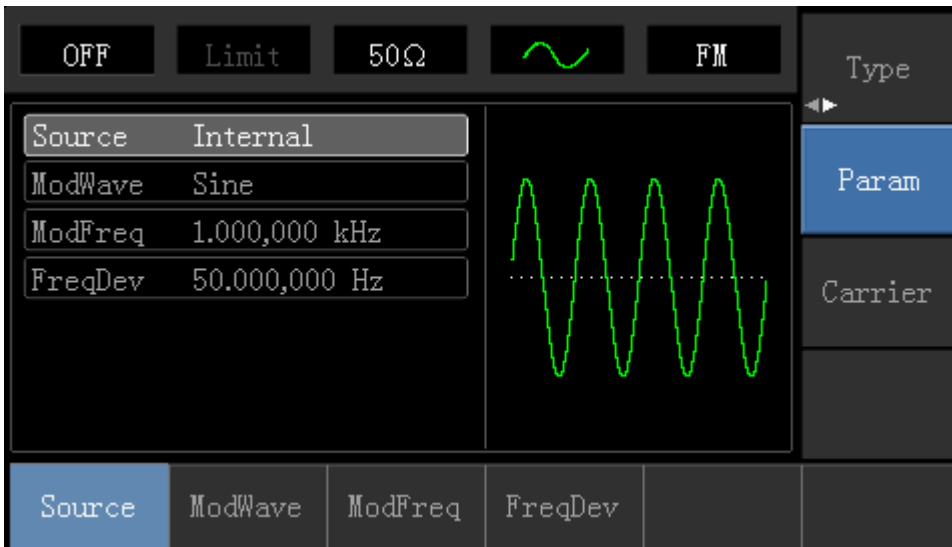

Press corresponding softkey, then enter required numerical value, and select the unit.

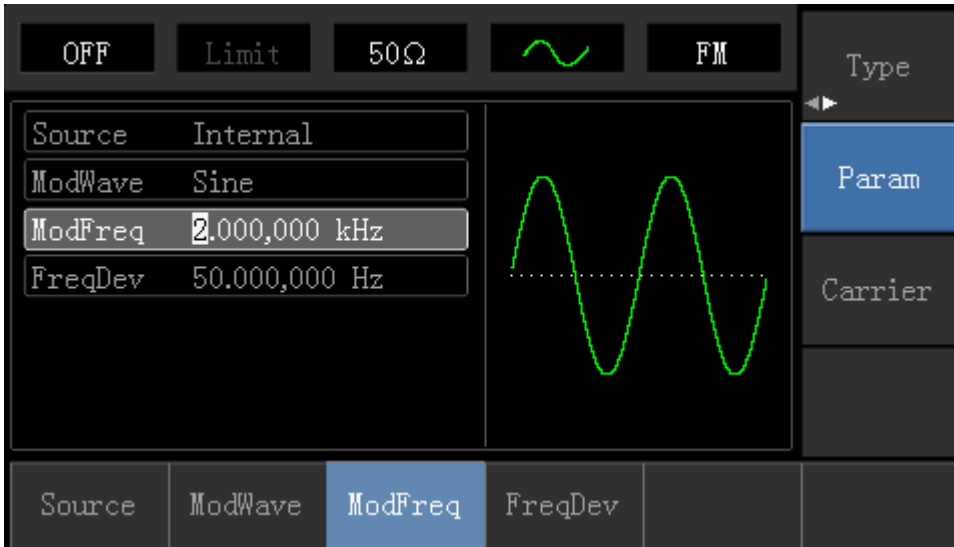

3) Set Carrier Wave Signal Parameter

Press **Carrier Wave Parameter** → **Type** → **Sine Wave** in turn to select sine wave as carrier wave signal.

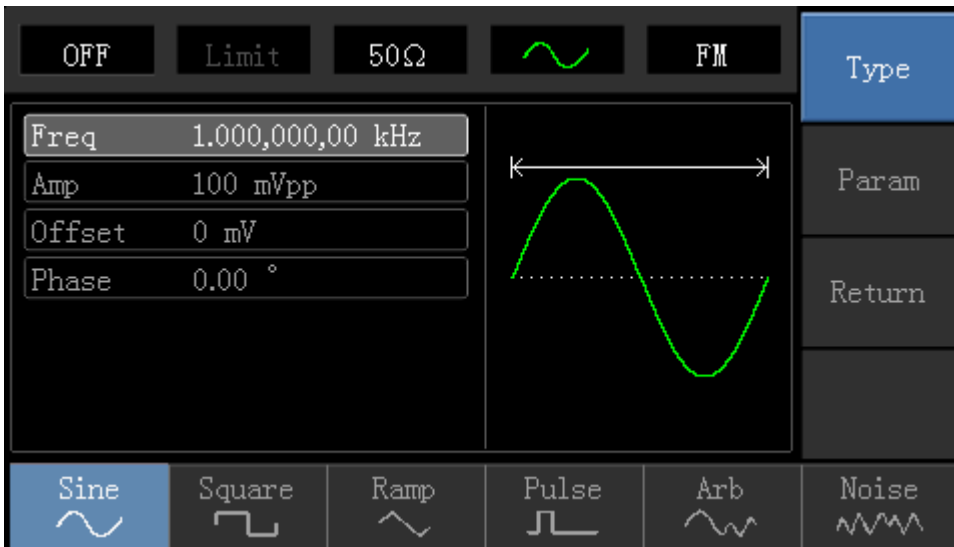

Press **Parameter** softkey, and the interface will pop up as following:

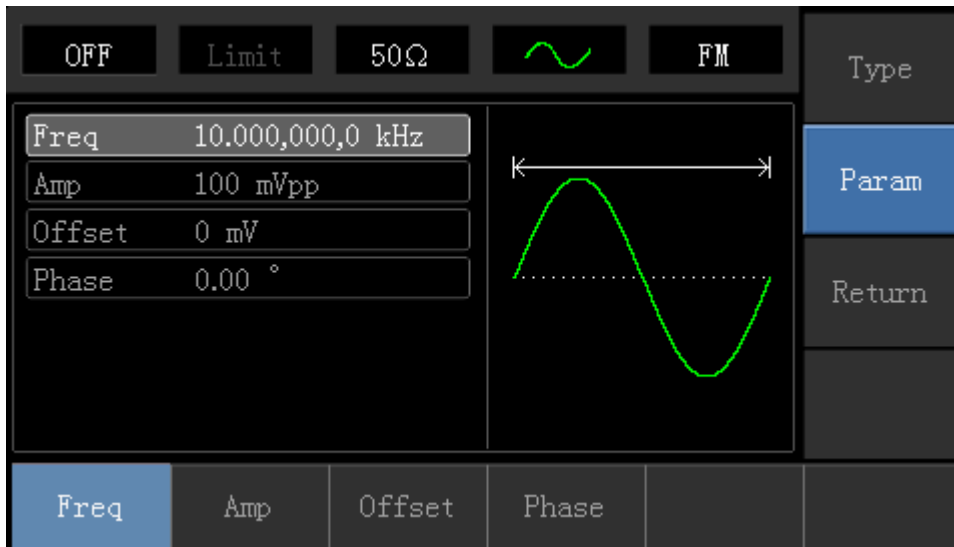

Press corresponding softkey first, then enter required numerical value, and select the unit.

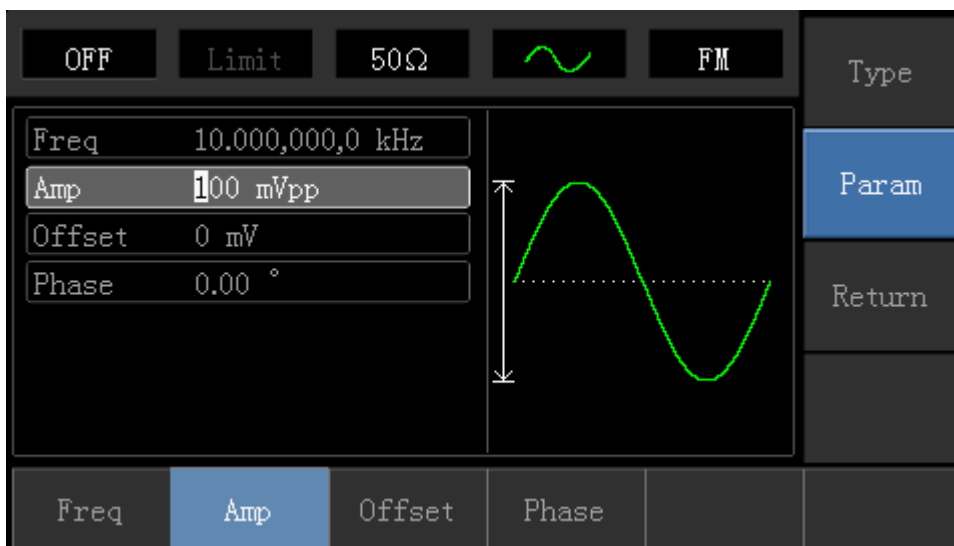

4) Set Frequency Deviation

After setting carrier wave parameter, press Return softkey to back to the following interface for setting frequency deviation.

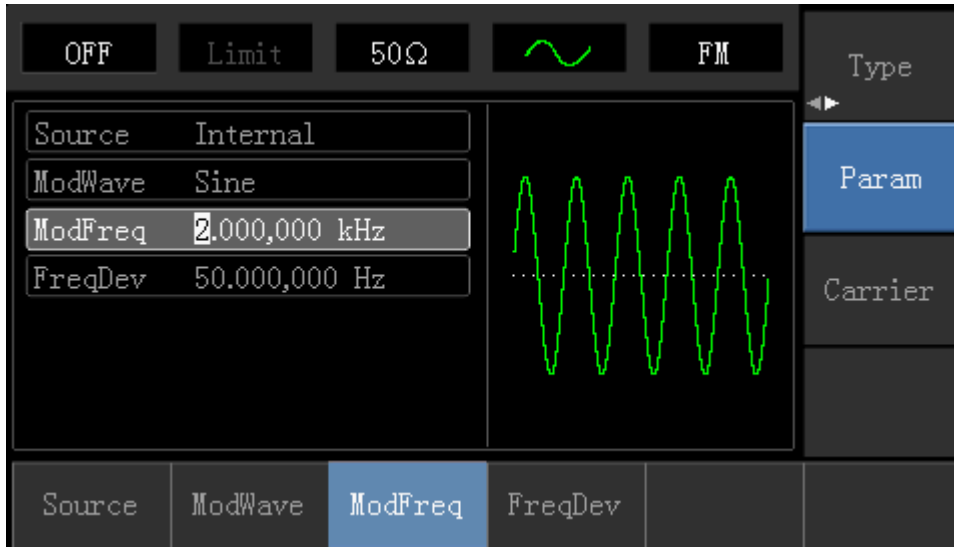

Press **Parameter** → **Frequency Deviation** softkey, then enter number 5 and press **kHz** softkey with number keyboard for setting frequency deviation.

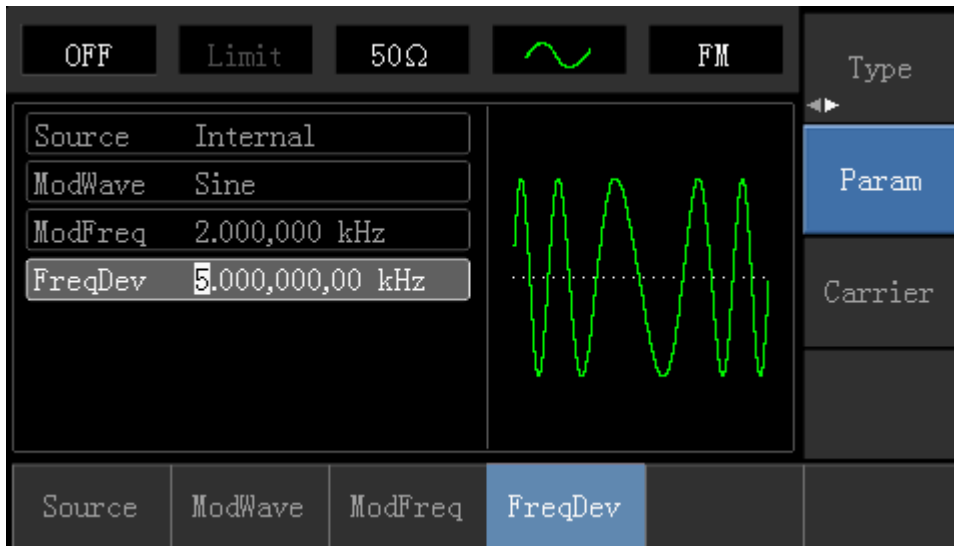

5) Enable Channel Output

Press Channel button to open channel output.

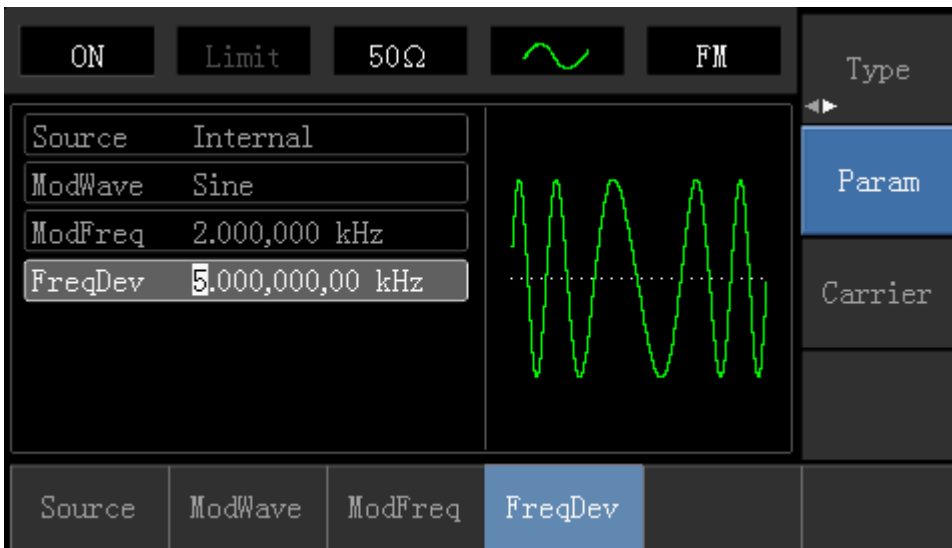

The shape of FM modulation waveform checked through oscilloscope is shown as following:

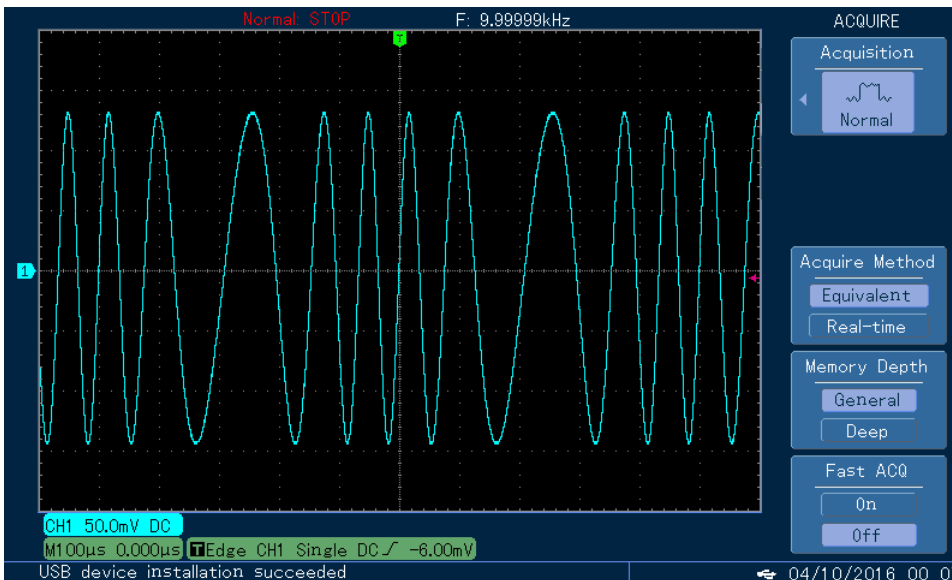

4.1.3 Phase Modulation (PM)

In phase modulation, modulated waveform is usually composed of carrier wave and modulation wave. The phase of carrier wave will change as the amplitude of modulation shape changes.

Press **Menu** → **Modulation** → **Type** → **Phase Modulation** in turn to start the PM function. The device will output modulated waveform with modulation waveform and carrier wave set currently.

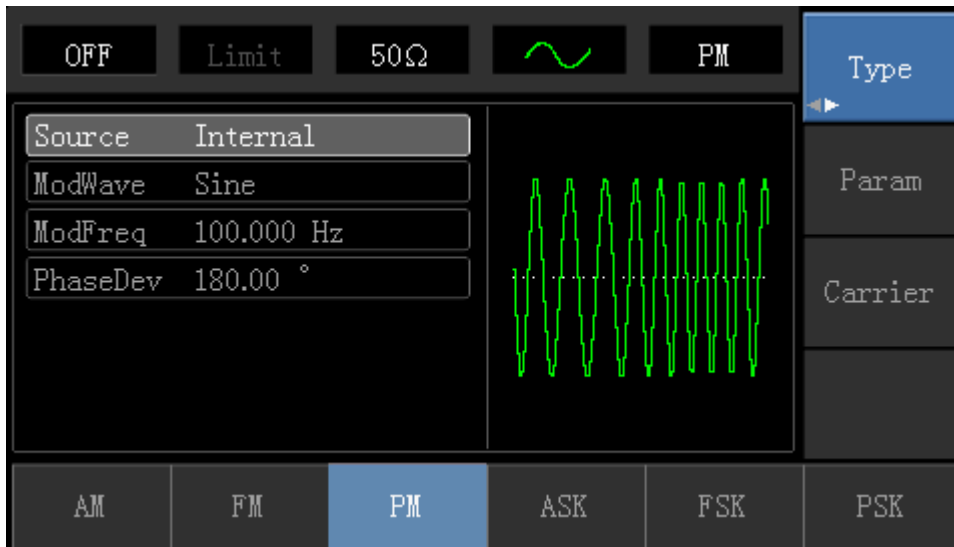

Carrier Wave Waveform Selection

PM carrier waveform can be: Sine wave, square wave, ramp wave or arbitrary wave (except DC), and the default is sine wave. Press **Carrier Wave Parameter** softkey to select carrier waveform.

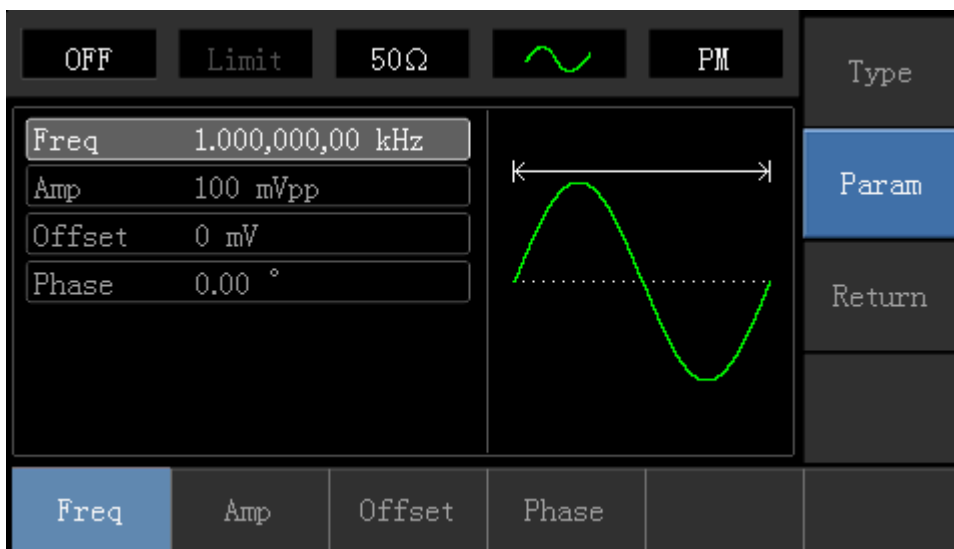

Carrier Wave Frequency Setting

Settable carrier wave frequency range is different of different carrier waveform. Default frequency of all carrier wave is 1kHz. The frequency setting range of each carrier wave can be seen in the following table:

Carrier Wave Waveform	Frequency			
	UTG1010A		UTG1005A	
	Minimum Value	Maximum Value	Minimum Value	Maximum Value

Sine Wave	1μHz	10MHz	1μHz	5MHz
Square wave	1μHz	5MHz	1μHz	5MHz
Ramp Wave	1μHz	400kHz	1μHz	400kHz
Arbitrary Wave	1μHz	2MHz	1μHz	1MHz

Press **Parameter** → **Frequency** softkey to enter carrier wave frequency setting, then enter required numerical value, and select unit.

Modulation Source Selection

This device can select internal modulation source or external modulation source. After enabling PM function, the default of modulation source is internal. If need to change, press

Parameter → **ModulationSource** → **External** in turn.

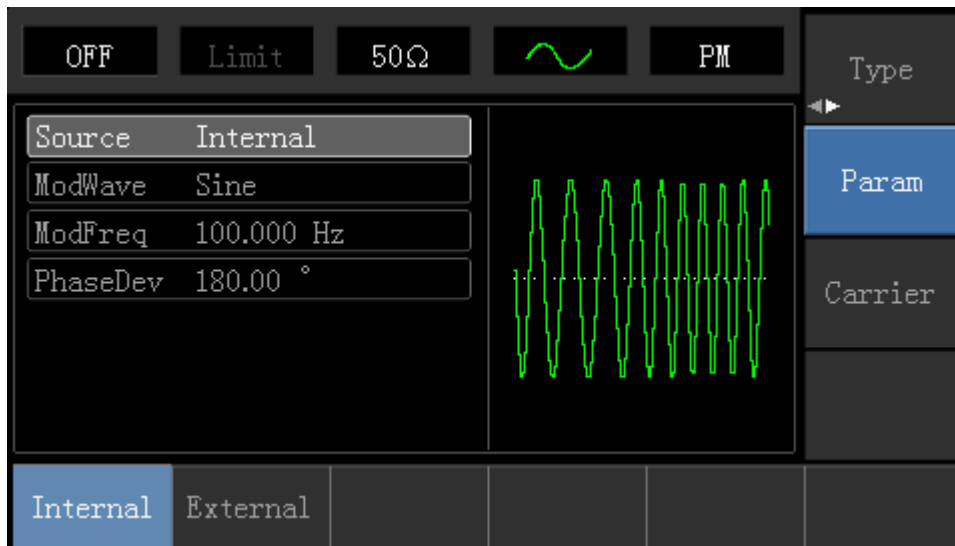

1) Internal Source

When modulation source is internal, modulation shape can be: sine wave, square wave, rising ramp wave, falling ramp wave, arbitrary wave and noise. After enabling PM function, the default of modulation wave is sine wave. If need to change, press **Carrier Wave Parameter** → **Type** in turn.

2) External Source

When modulation source is external, carrier waveform will be modulated by an external waveform. PM phase deviation is controlled by ±5V signal level of external modulation input terminal on front panel. For example, if phase deviation value in parameter list has been set to 180°, +5V of external modulation signal is equivalent to 180° phase shift.

Modulation Shape Frequency Setting

When modulation source is internal, frequency of modulation shape can be modulated. After enabling PM function, the default of modulation shape frequency is 100Hz. If need to change, press **Carrier** **Wave Parameter** → **Modulation Frequency** in turn, and the modulation frequency range is 2mHz to 50kHz. When modulation source is external, carrier waveform will be modulated by an external waveform. The range of modulation signal input from external is 0Hz to 20Hz.

Phase Deviation Setting

Phase deviation indicates the change between the phases of PM modulated waveform and the phase of carrier wave phase. Settable range of PM phase deviation is from 0° to 360°, and the default value is 50°. If need to change, press **Parameter** → **Phase Deviation** in turn.

Comprehensive Example

Firstly, make the instrument work in phase modulation (PM) mode, then set a sine wave with 200Hz from the internal of the instrument as a modulation signal and a square with frequency of 900Hz and amplitude of 100mVpp as a carrier wave signal. Finally, set the phase deviation to 200°. Specific steps are seen as following:

1) Enable Phase Modulation (PM) Function

Press **Menu** → **Modulation** → **Type** → **Phase Modulation** in turn to start the PM function.

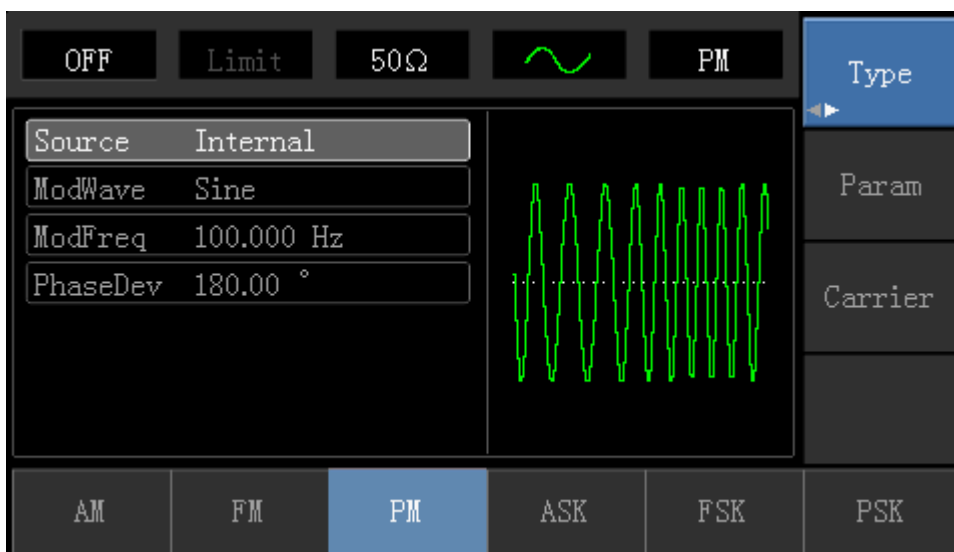

2) Set Modulation Signal Parameter

Press **Parameter** softkey and the interface will show as following:

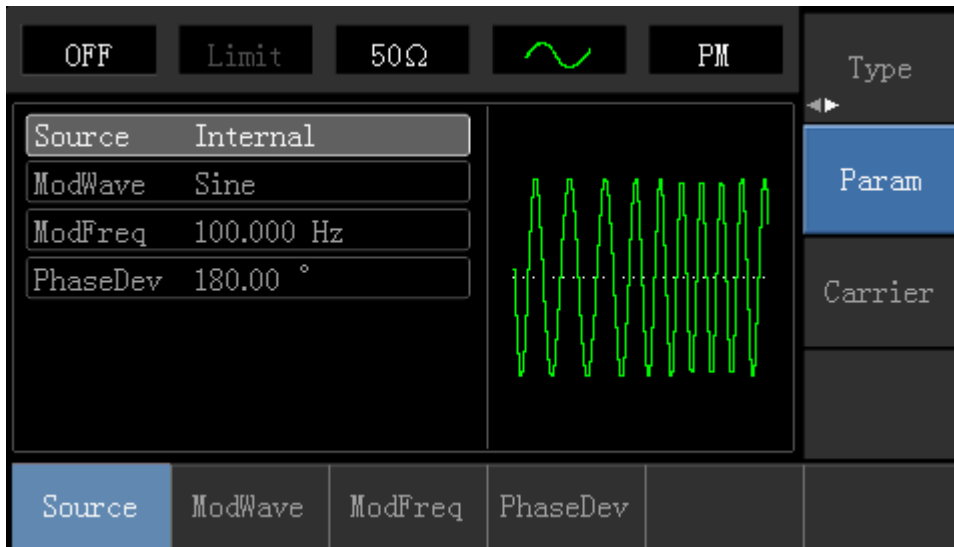

Press corresponding softkey first, then enter required numerical value, and select the unit.

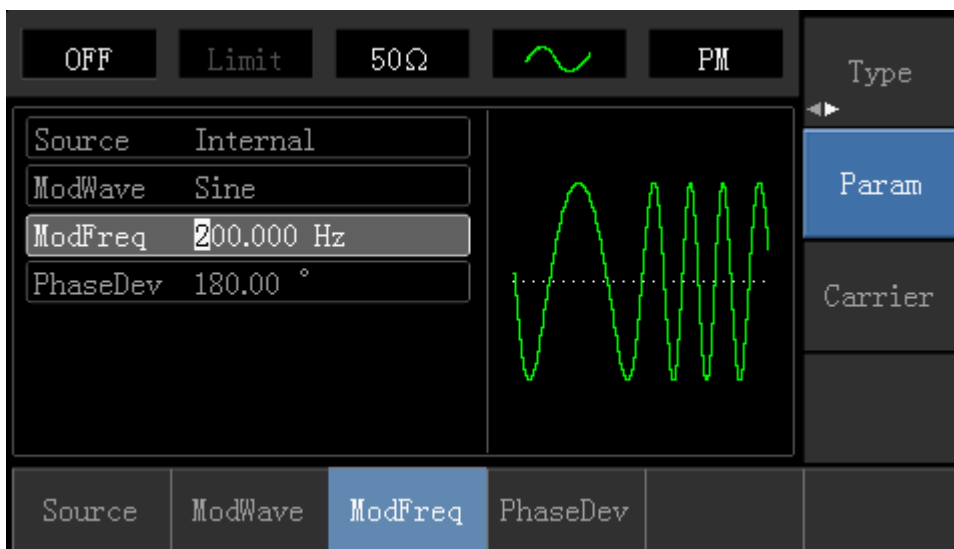

3) Set Carrier Wave Signal Parameter

Press **Carrier Wave Parameter** → **Type** → **Sine Wave** in turn to select sine wave as carrier wave signal.

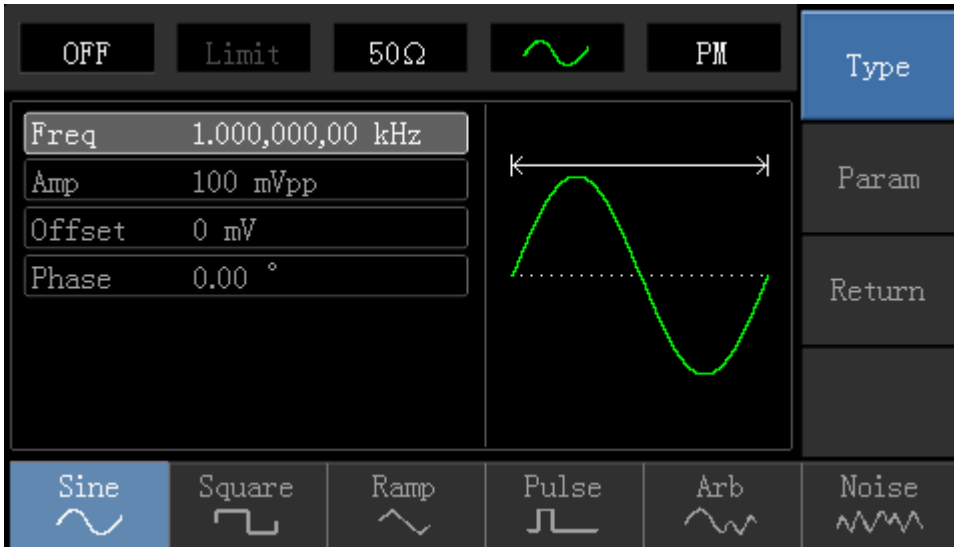

Press **Parameter** softkey, and the interface will pop up as following:

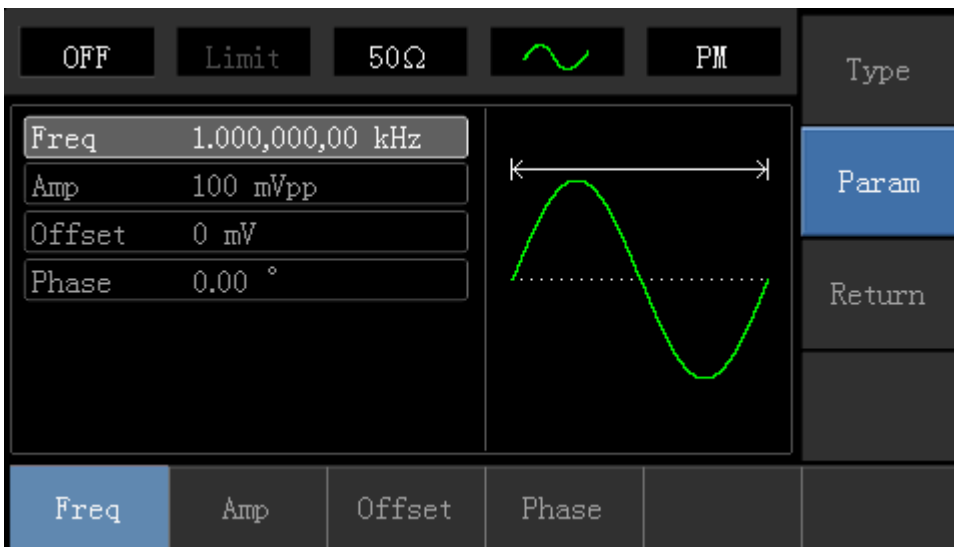

Press corresponding softkey, then enter required numerical value, and select the unit.

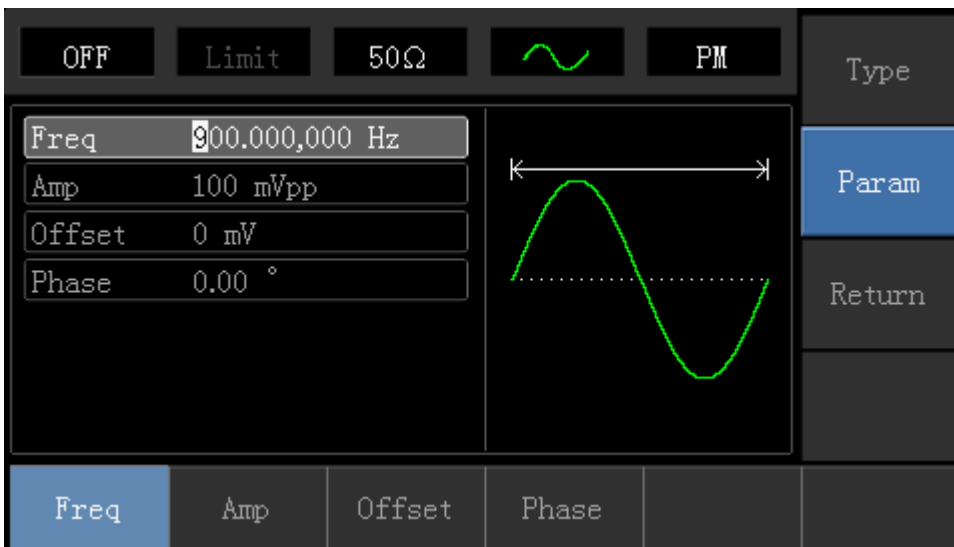

4) Set Phase Deviation

Press **Return** softkey to back to the following interface for setting phase modulation.

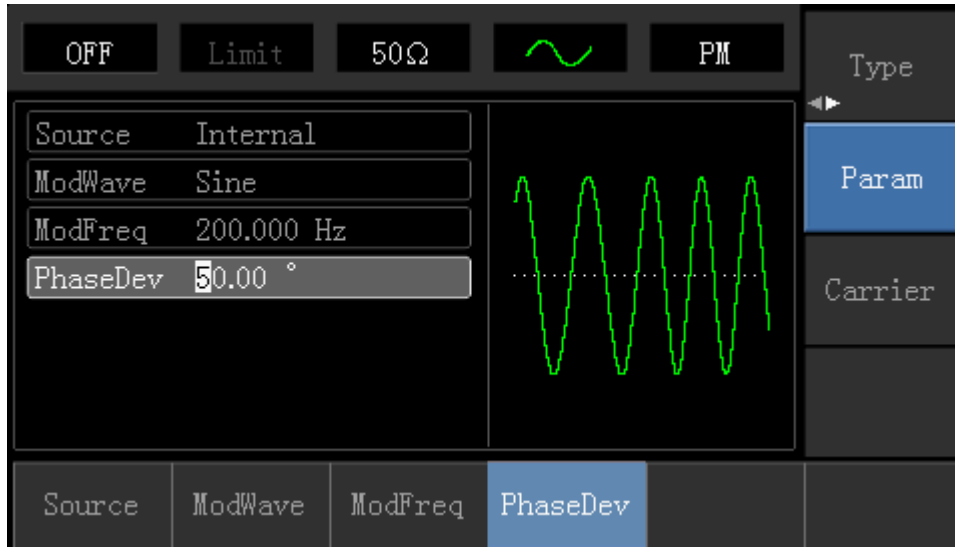

Press **Parameter** → **Phase Deviation** softkey, then enter number 200 and press **0** softkey with number keyboard for setting phase deviation.

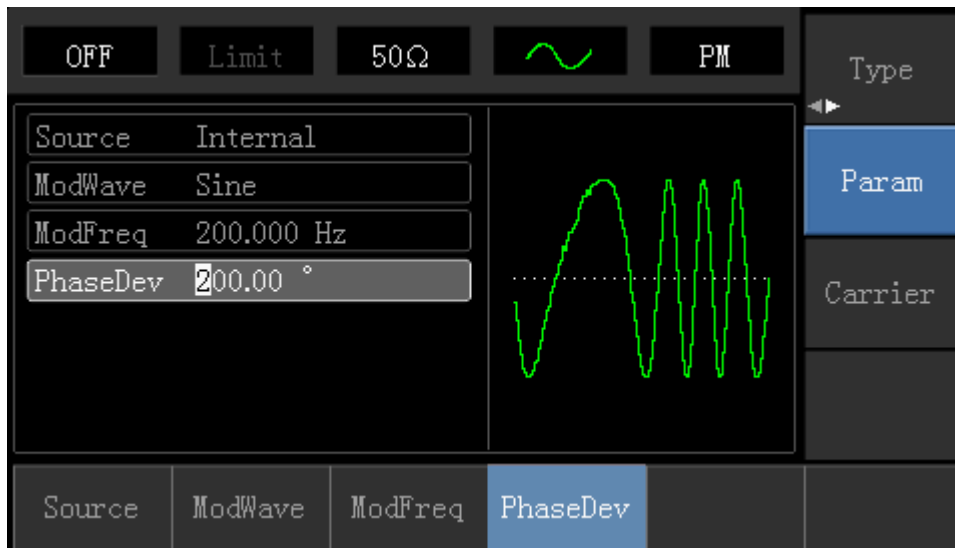

5) Enable Channel Output

Press **Channel** button to open channel output quickly.

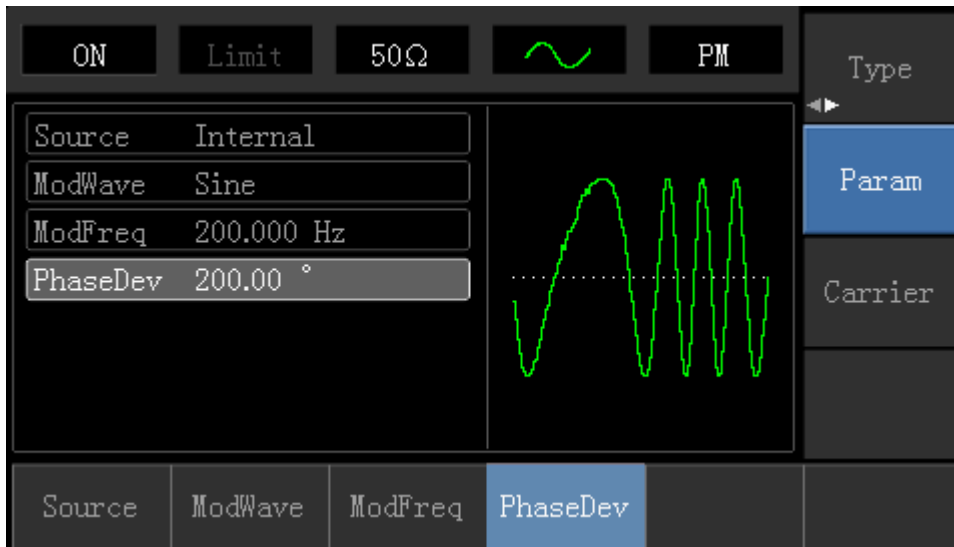

The shape of PM modulation waveform checked through oscilloscope is shown as following:

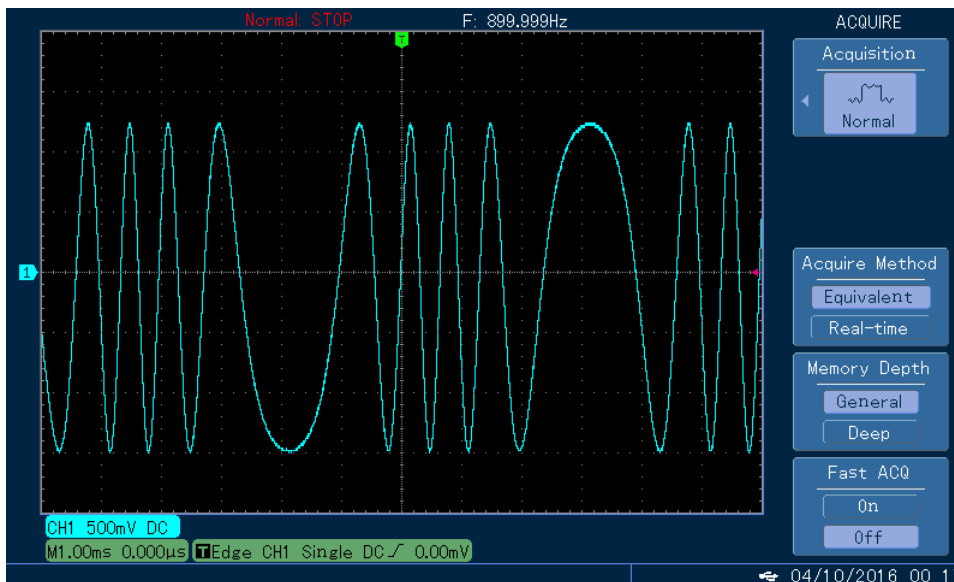

4.1.4 Amplitude Shift Keying (ASK)

ASK represents digital signal “0” and “1” by changing amplitude of carrier wave signal. Carrier wave signal with different amplitude will be output on the basis of different logic of modulation signal.

ASK Modulation Selection

Press **Menu** → **Modulation** → **Type** → **Amplitude Shift Keying** in turn to start the ASK function, the device will output modulated waveform with ASK rate and carrier wave set currently.

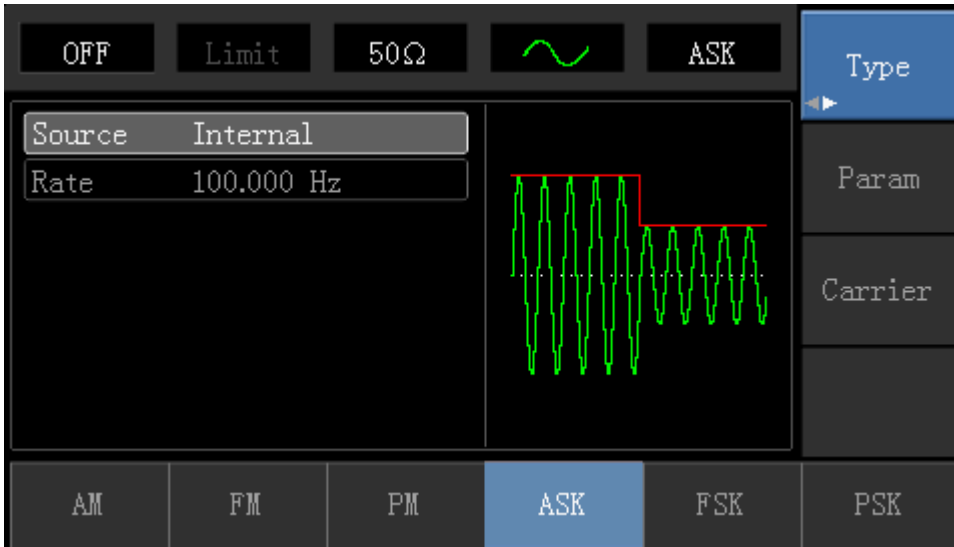

Carrier Wave Waveform Selection

ASK carrier waveform can be: Sine wave, square, ramp wave or arbitrary wave (except DC), and the default is sine wave. Press **Carrier Wave Parameter** softkey to enter carrier waveform selection interface.

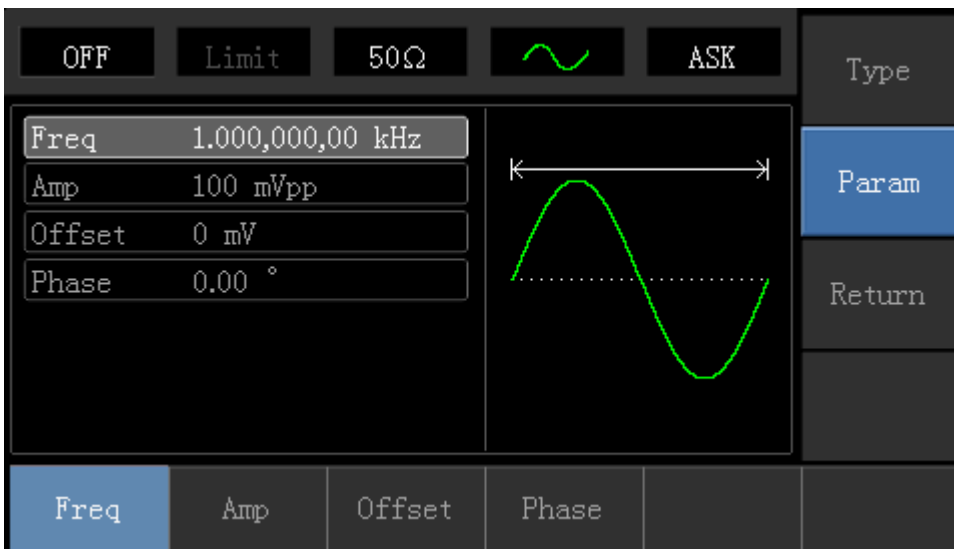

Carrier Wave Frequency Setting

Settable carrier wave frequency range is different of different carrier waveform. Default frequency of all carrier wave is 1kHz. The frequency setting range of each carrier wave can be seen in the following table:

Carrier Wave Waveform	Frequency			
	UTG1010A		UTG1005A	
	Minimum Value	Maximum Value	Minimum Value	Maximum Value

Sine Wave	1μHz	10MHz	1μHz	5MHz
Square Wave	1μHz	5MHz	1μHz	5MHz
Ramp Wave	1μHz	400kHz	1μHz	400kHz
Arbitrary Wave	1μHz	2MHz	1μHz	1MHz

Press **Parameter** → **Frequency** softkey, then enter required number value, and select unit.

Modulation Source Selection

The device can select internal modulation source or external modulation source. After enabling ASK function, the default of modulation source is internal. If need to change, press

Parameter → **ModulationSource** → **External** in turn.

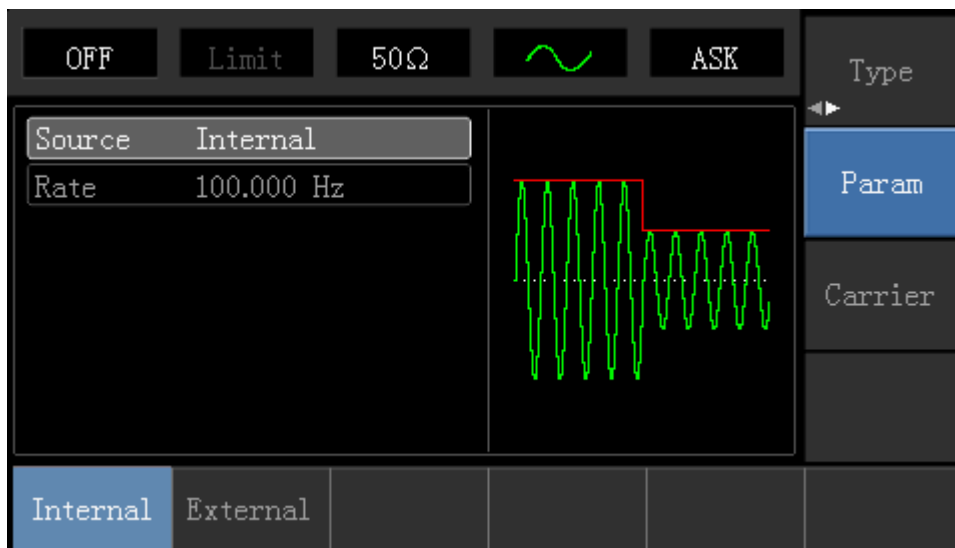

1) Internal Source

When modulation source is internal, internal modulation wave is a square wave of 50% duty cycle (not adjustable). The ASK rate can be set to customize modulated waveform amplitude hopping frequency.

2) External Source

When modulation source is external, carrier waveform will be modulated by an external waveform. ASK output amplitude is determined by the logic level of modulation interface on front panel. For example, output the carrier wave amplitude of current setting when external input logic is low, and output carrier wave amplitude less than the amplitude of current setting when external input logic is high.

ASK Rate Setting

When modulation source is internal, frequency of ASK amplitude jump can be modulated. After enabling ASK function, ASK rate can be set and the settable range is 2mHz to 100kHz, the default rate is 1kHz. If need to change, press **Carrier Wave Parameter** → **Rate** in turn.

Comprehensive Example

Make the instrument work in amplitude shift keying (ASK) mode, then set a logic signal with 300Hz from the internal of the instrument as a modulation signal and a sine wave with frequency of 15kHz and amplitude of 2Vpp as a carrier wave signal. Specific steps are seen as following:

1) Enable Amplitude Shift Keying (ASK) Function

Press **Menu** → **Modulation** → **Type** → **Amplitude Shift Keying** in turn to start the ASK function.

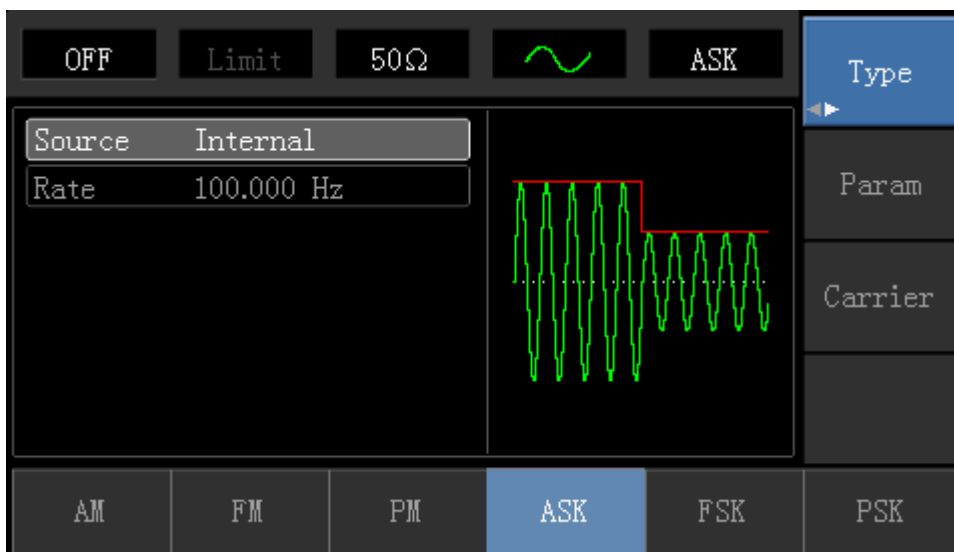

2) Set Carrier Wave Signal Parameter

Press **Carrier Wave Parameter** → **Type** → **Sine Wave** in turn

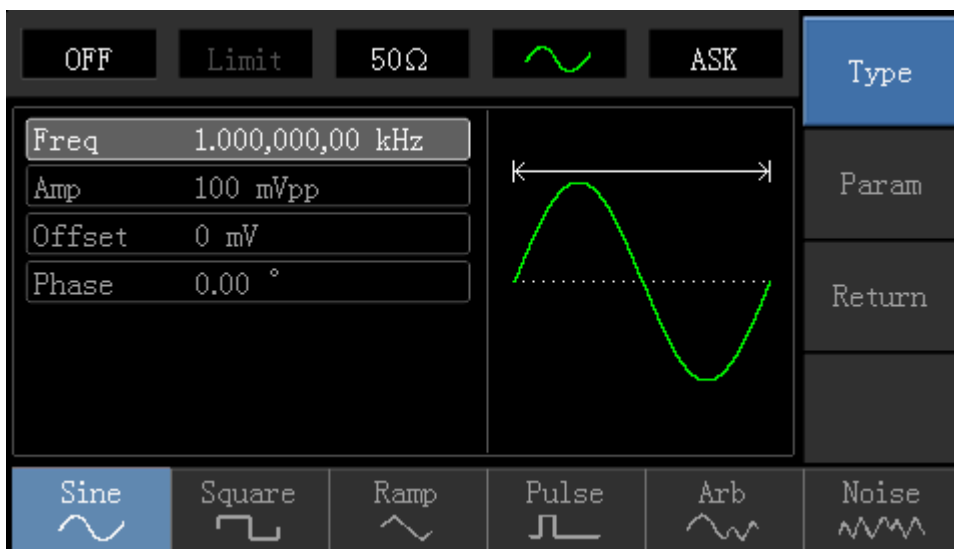

Press **Parameter** softkey, and the interface will pop up as following:

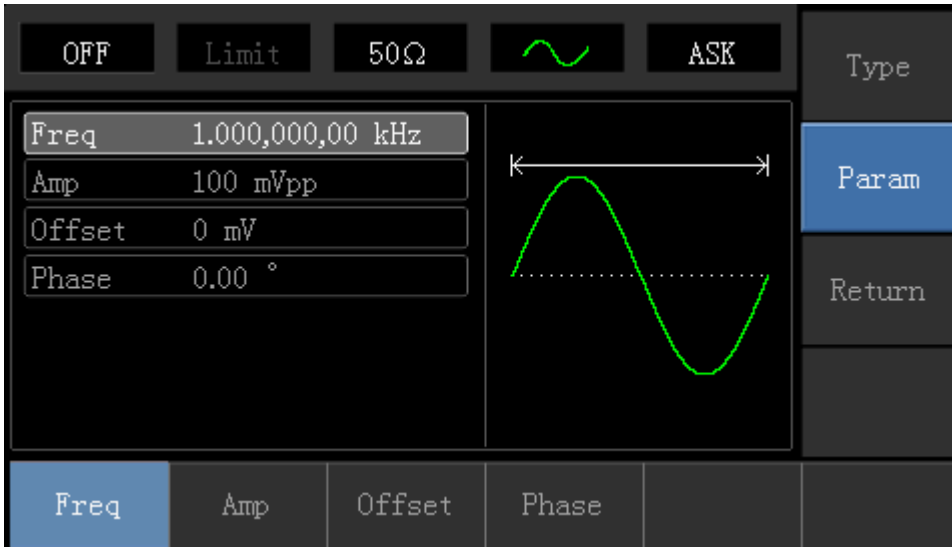

Press corresponding softkey, then enter required numerical value, and select the unit.

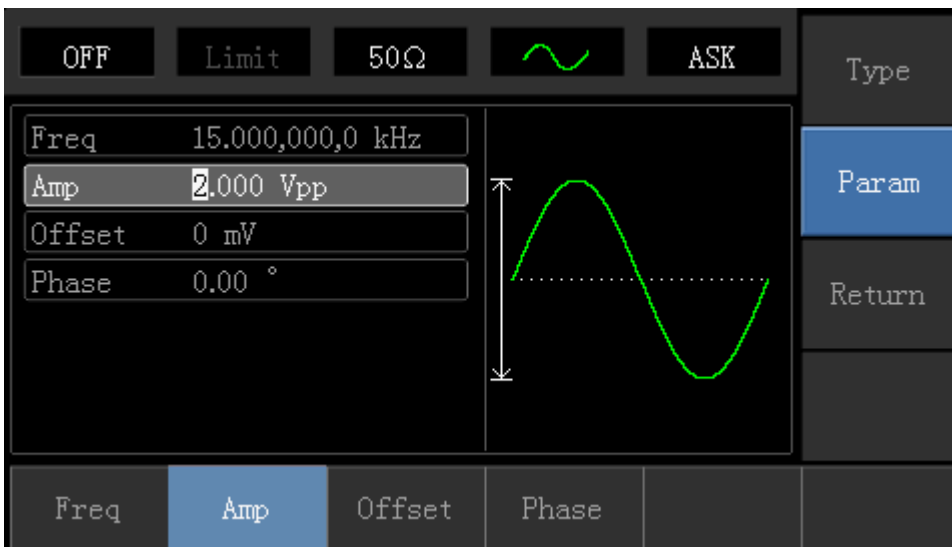

3) Set ASK Rate

After setting carrier wave parameter, press Return softkey to go back to the following interface for setting phase modulation.

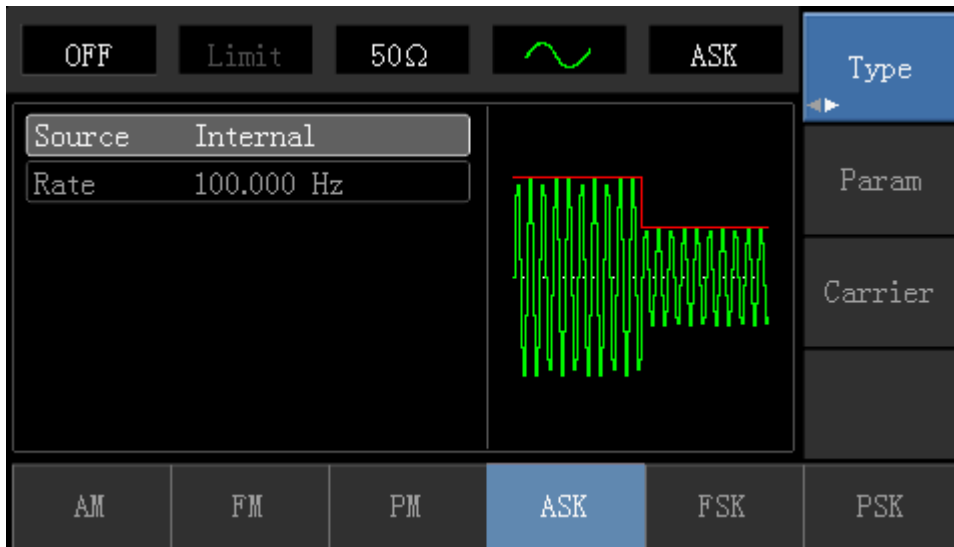

Press **Parameter** → **Rate** softkey again, then enter number 300 and press **Hz** softkey with number keyboard for setting ASK rate.

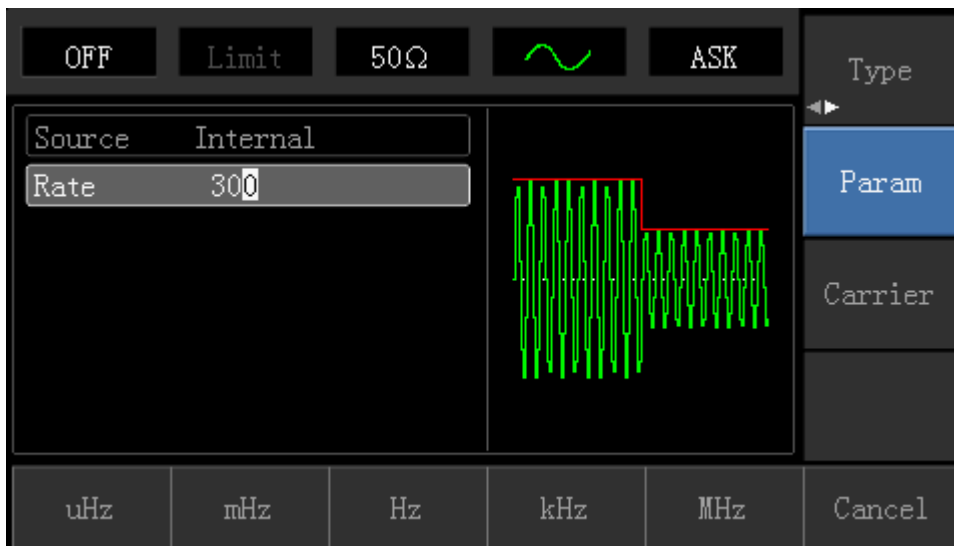

4) Enable Channel Output

Press Channel button to open channel output quickly.

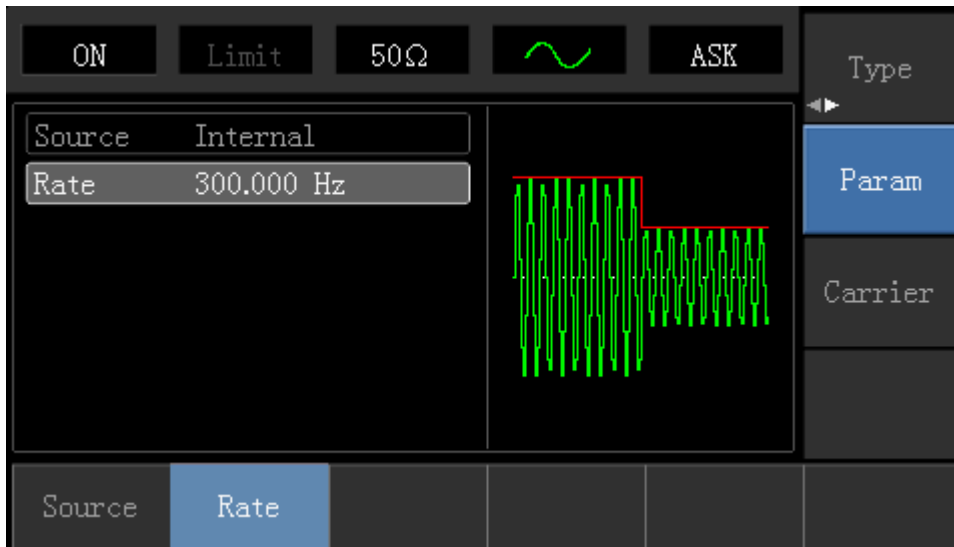

The shape of ASK modulation waveform checked through oscilloscope is shown as following:

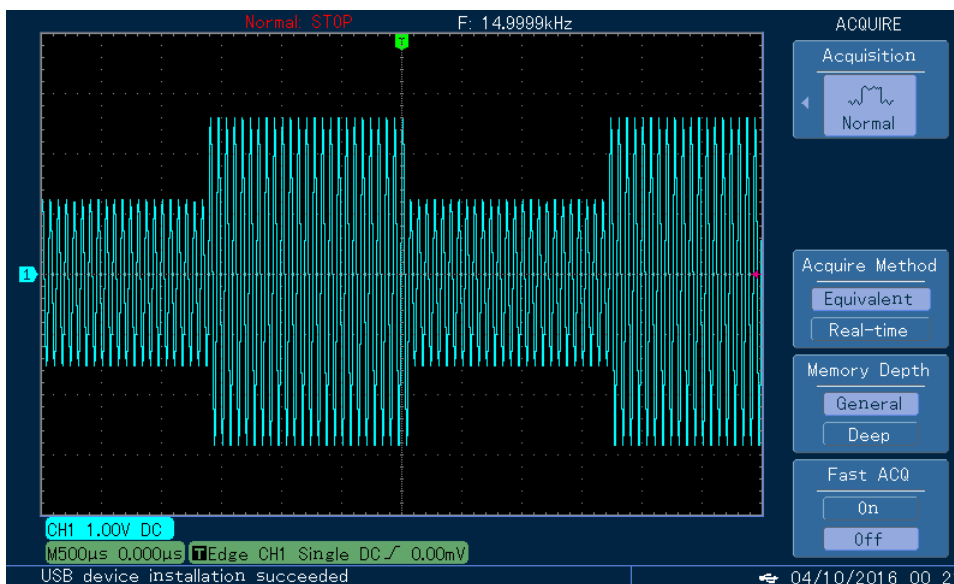

4.1.5 Frequency Shift Keying (FSK)

In frequency shift keying, rate of carrier wave frequency and hopping frequency can be changed.

FSK Modulation Selection

Press **Menu** → **Modulation** → **Type** → **Frequency Shift Keying** in turn to start the FSK function. The device will output modulated waveform with current setting.

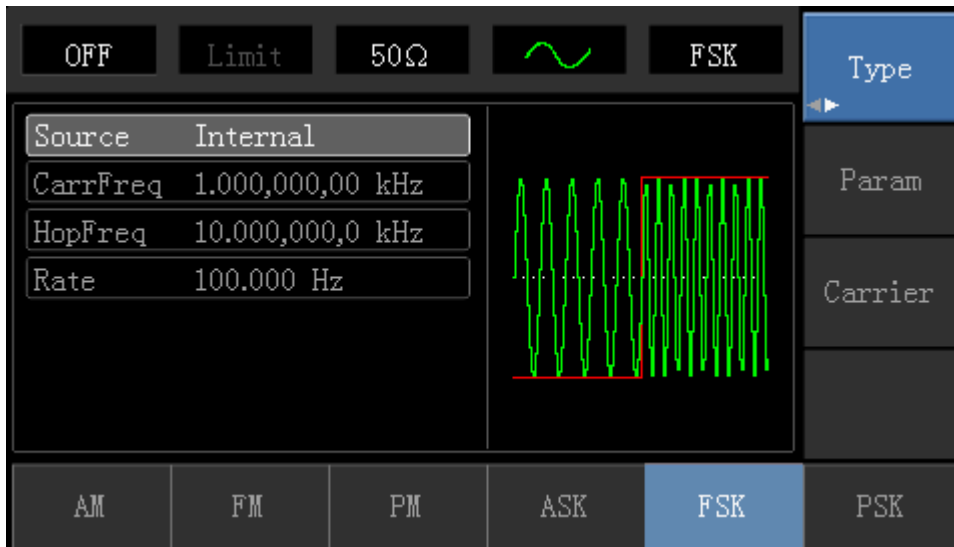

Carrier Wave Waveform Selection

Press **Carrier Wave Parameter** softkey to enter carrier waveform selection interface. FSK carrier waveform can be: sine wave, square wave, ramp wave or arbitrary wave (except DC), and the default is sine wave.

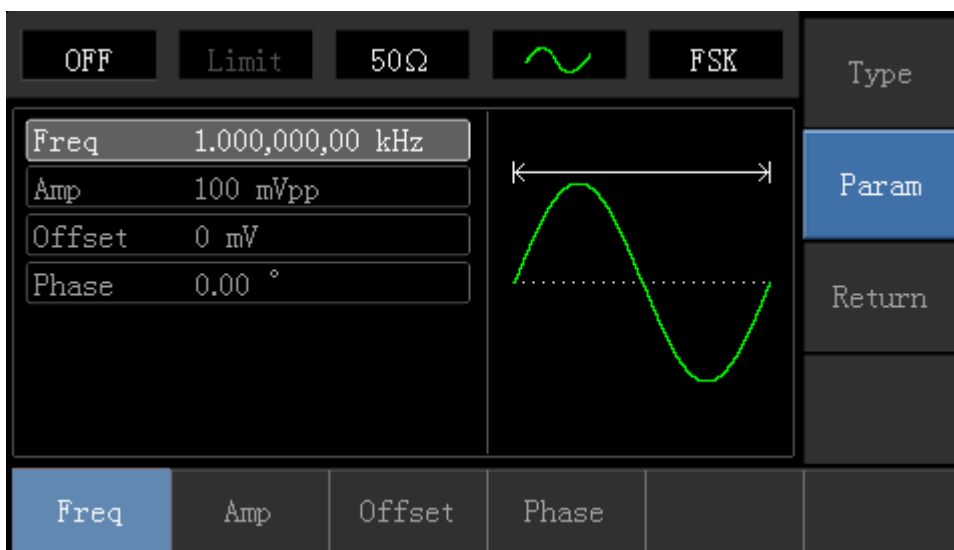

Carrier Wave Frequency Setting

Settable carrier wave frequency range is different of different carrier waveform. Default frequency of all carrier wave is 1kHz. The frequency setting range of each carrier wave can be seen in the following table:

Carrier Wave Waveform	Frequency			
	UTG1010A		UTG1005A	
	Minimum Value	Maximum Value	Minimum Value	Maximum Value
Sine Wave	1μHz	10MHz	1μHz	5MHz

Square Wave	1μHz	5MHz	1μHz	5MHz
Ramp Wave	1μHz	400kHz	1μHz	400KHz
Arbitrary Wave	1μHz	2MHz	1μHz	1MHz

Press **Parameter** → **Frequency** softkey, then enter required numerical value, and select unit.

Modulation Source Selection

The device can select internal modulation source or external modulation source. After enabling FSK function, the default of modulation source is internal. If need to change, press

Parameter → **ModulationSource** → **External** in turn.

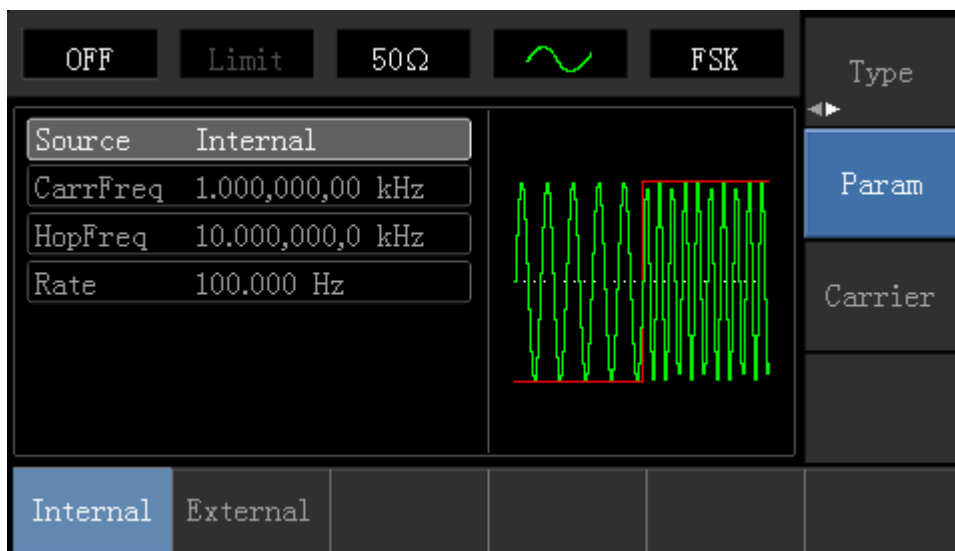

1) Internal Source

When modulation source is internal, internal modulation wave is a square of 50% duty cycle (not adjustable). The FSK rate can be set to customize the moving frequency between carrier wave frequency and hop frequency.

2) External Source

When modulation source is external, carrier waveform will be modulated by an external waveform. FSK output frequency is determined by the logic level of modulation interface on front panel. For example, output the carrier wave frequency when external output logic is low, and output hop frequency when external input logic is high.

Hop Frequency Setting

After enabling FSK function, the default of hop frequency is 2MHz. If need to change, press **Parameter** → **Hop Frequency** in turn. Settable range of hop frequency is determined by carrier wave waveform. See the following table for setting range of each carrier wave frequency:

Carrier Wave Waveform	Frequency			
	UTG1010A		UTG1005A	
	Minimum Value	Maximum Value	Minimum Value	Maximum Value
Sine Wave	1μHz	10MHz	1μHz	5MHz
Square Wave	1μHz	5MHz	1μHz	5MHz
Ramp Wave	1μHz	400kHz	1μHz	400KHz
Arbitrary Wave	1μHz	2MHz	1μHz	1MHz

FSK Rate Setting

When modulation source is internal, the moving frequency between carrier wave frequency and hop frequency can be set. After enabling FSK function, FSK rate can be set and the settable range is 2mHz to 100kHz, the default rate is 1kHz. If need to change, press **Carrier Wave Parameter** → **Rate** in turn.

Comprehensive Example

Firstly, make the instrument work in frequency shift keying (FSK) mode, then set a sine wave with 2kHz and 1Vpp from the internal of the instrument as a carrier wave signal, and set hop frequency to 800 Hz, finally, make carrier wave frequency and hop frequency move between each other with 200Hz frequency. Specific steps are seen as following:

1) Enable Frequency Shift Keying (FSK) Function

Press **Menu** → **Modulation** → **Type** → **Frequency Shift Keying** in turn to start the FSK function.

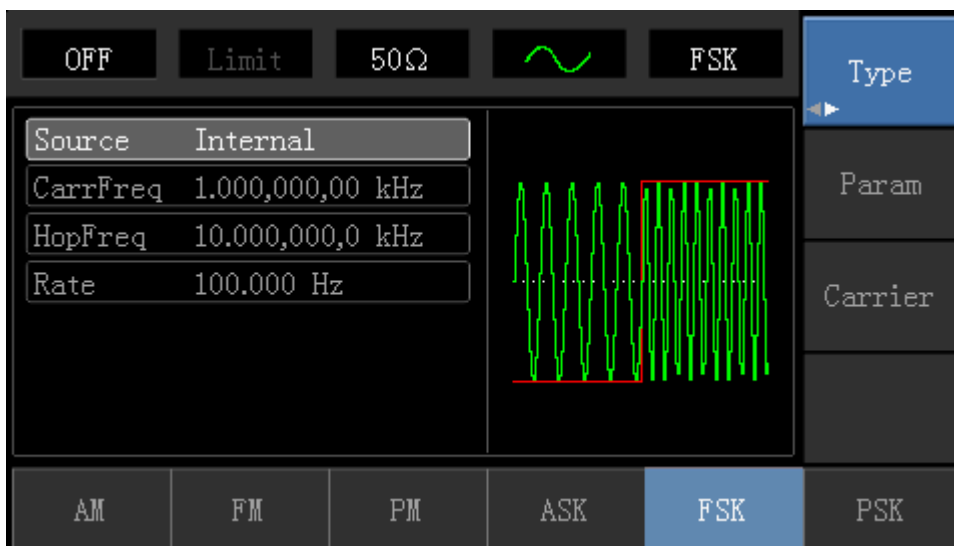

2) Set Carrier Wave Signal Parameter

Press **Carrier Wave Parameter** → **Type** → **Sine Wave** in turn to select sine wave as carrier wave.

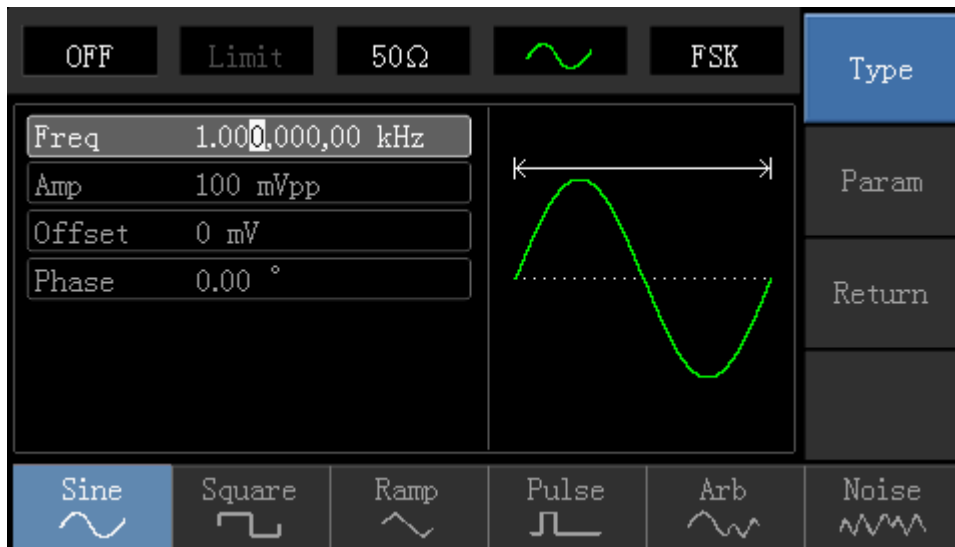

Press **Parameter** softkey again, and the interface will pop up as following:

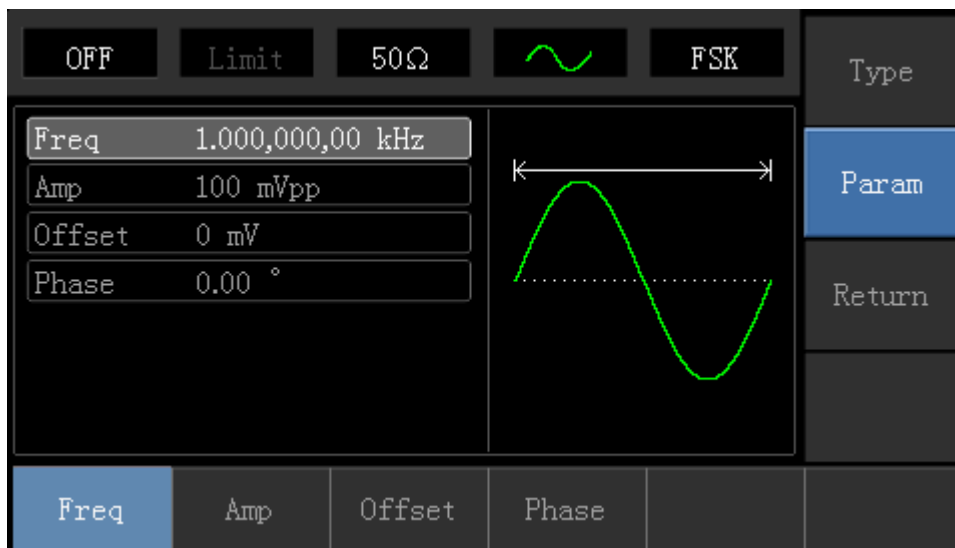

Press corresponding softkey first, then enter required numerical value, and select the unit.

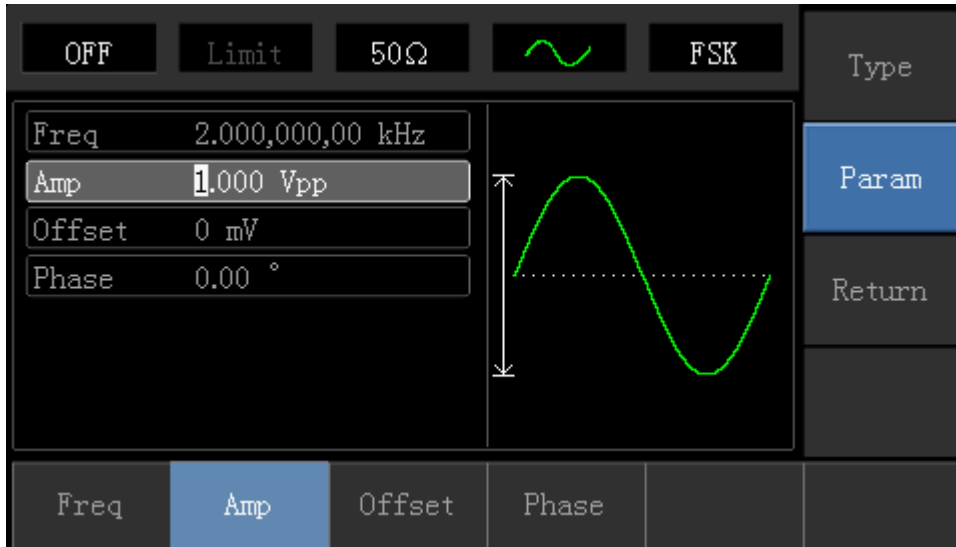

3) Set Hop Frequency and FSK Rate

Press **Return** softkey to go back to the following interface.

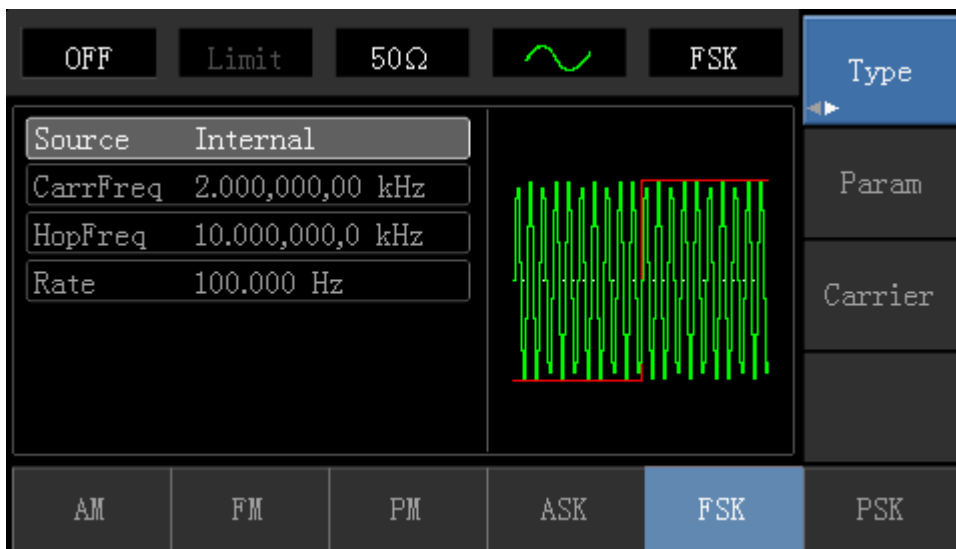

Press **Parameter** softkey again, and the interface will pop up as following:

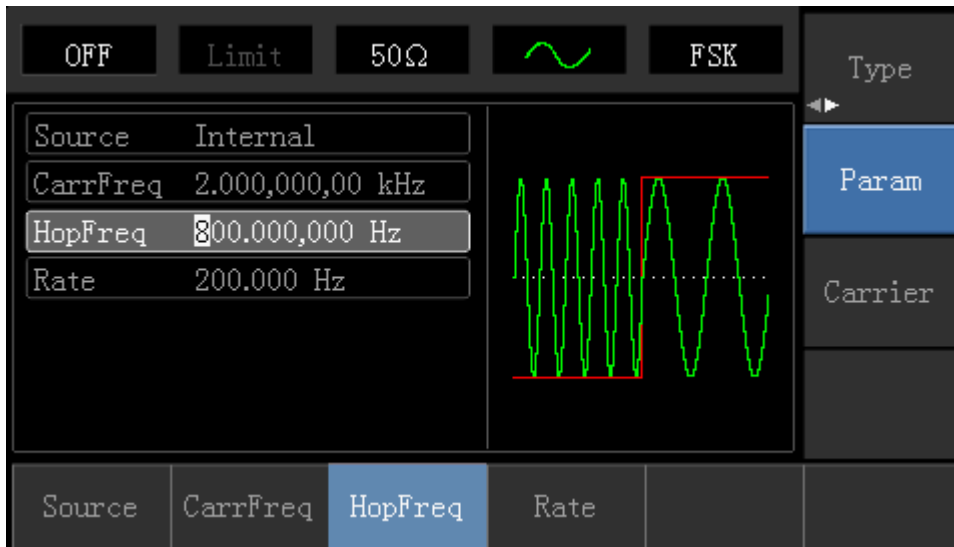

Press corresponding softkey first, then enter required numerical value, and select the unit.

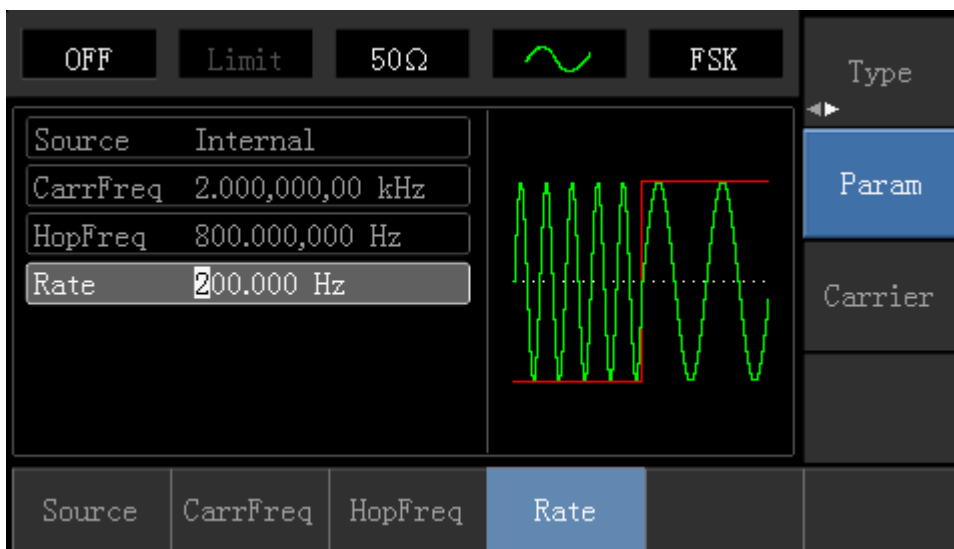

4) Enable Channel Output

Press Channel button on front panel to open channel output.

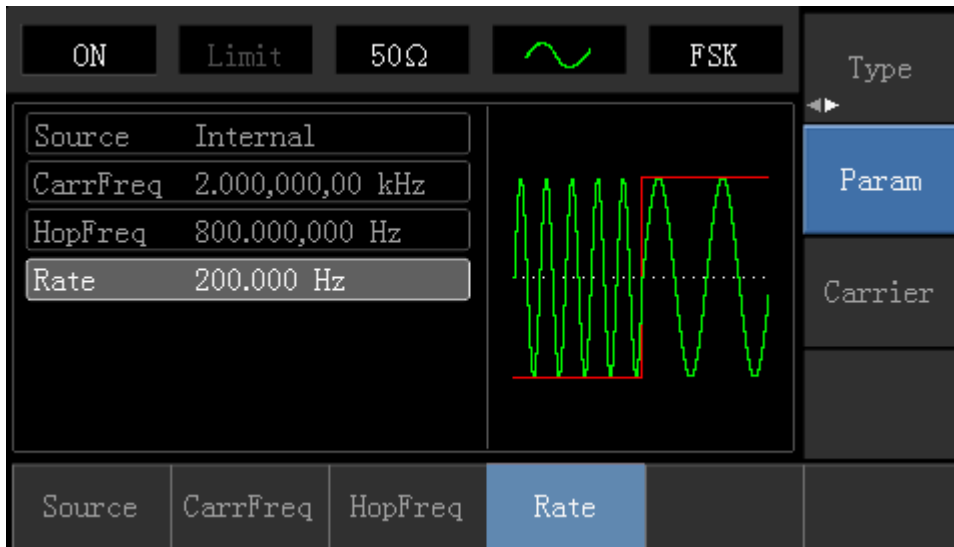

The shape of FSK modulation waveform checked through oscilloscope is shown as following:

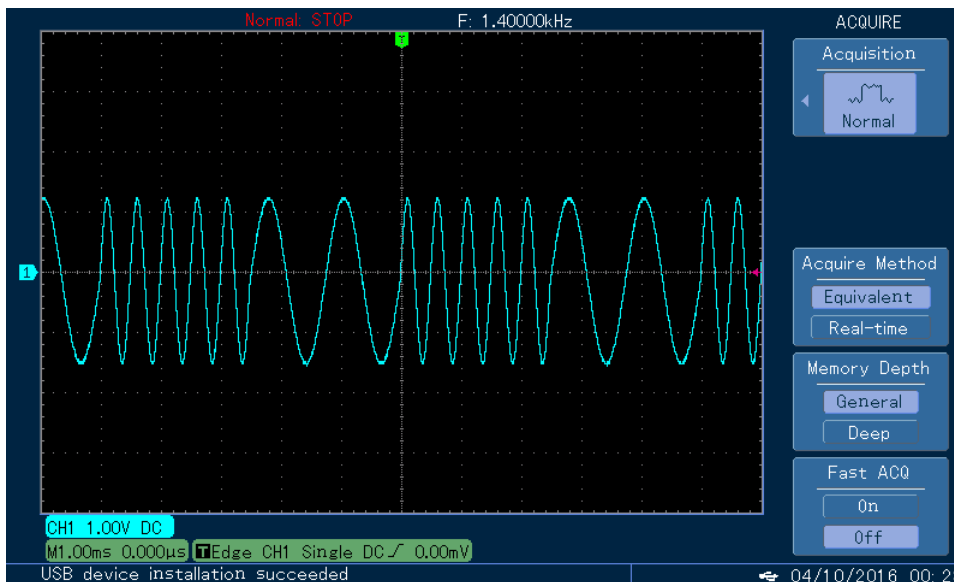

4.1.6 Phase Shift Keying (PSK)

In phase shift keying, DDS function generator can be configured to move between two preset phase (carrier wave phase and modulation phase). Output carrier wave signal phase or hop signal phase on the basis of the logic of modulation signal.

PSK Modulation Selection

Press **Menu** → **Modulation** → **Type** → **Phase Shift Keying** in turn to start the PSK function. The device will output modulated waveform with carrier wave phase (the default is 0° and is not adjustable) of current setting and modulation phase.

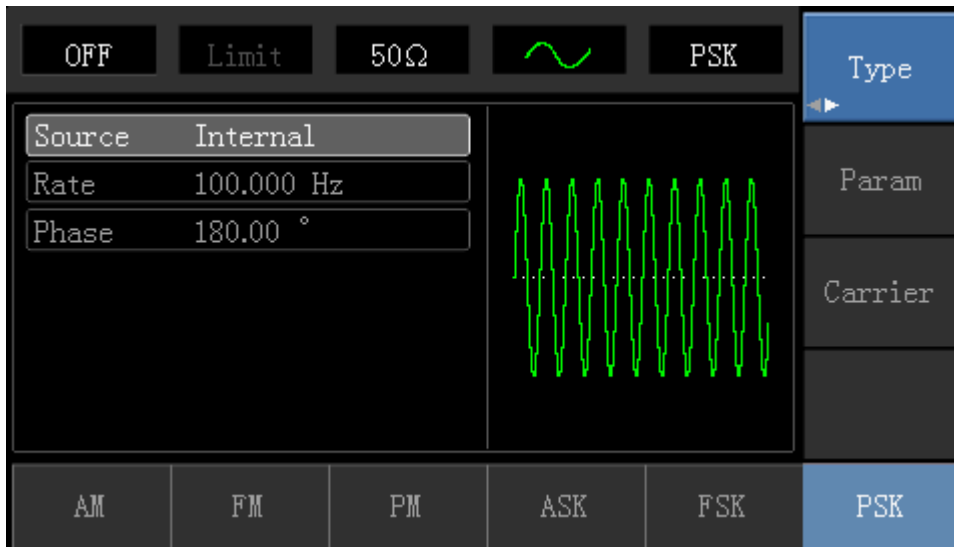

Carrier Wave Waveform Selection

PSK carrier waveform can be: Sine wave, square, ramp wave or arbitrary wave (except DC), and the default is sine wave. Press **Carrier Wave Parameter** softkey to enter carrier waveform selection interface.

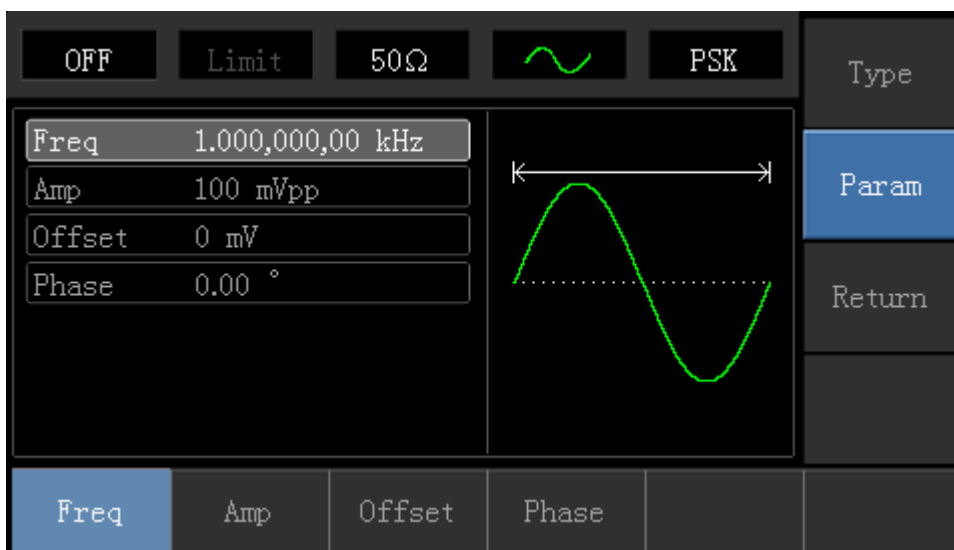

Carrier Wave Frequency Setting

Settable carrier wave frequency range is different of different carrier waveform. Default frequency of all carrier wave is 1kHz. The frequency setting range of each carrier wave can be seen in the following table:

Carrier Wave Waveform	Frequency			
	UTG1010A		UTG1005A	
	Minimum Value	Maximum Value	Minimum Value	Maximum Value
Sine Wave	1μHz	10MHz	1μHz	5MHz

Square Wave	1μHz	5MHz	1μHz	5MHz
Ramp Wave	1μHz	400kHz	1μHz	400KHz
Arbitrary Wave	1μHz	2MHz	1μHz	1MHz

Press **Parameter** → **Frequency** softkey, then enter required numerical value, and select unit.

Modulation Source Selection

UTG1000A function/arbitrary waveform generator can select internal modulation source or external modulation source. After enabling PSK function, the default of modulation source is internal. If need to change, press **Parameter** → **Modulation** → **Source** → **External** in turn.

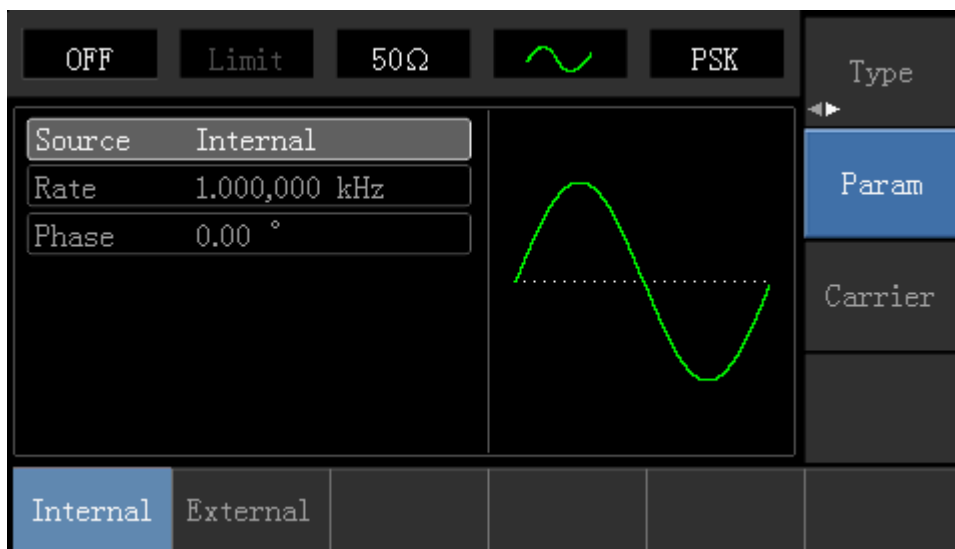

1) Internal Source

When modulation source is internal, internal modulation wave is a square wave of 50% duty cycle (not adjustable). The PSK rate can be set to customize the moving frequency between carrier wave phase and modulation phase.

2) External Source

When modulation source is external, carrier waveform will be modulated by an external waveform. Carrier wave phase will be output when external input logic is low, and modulation phase will be output when external input logic is high.

PSK Rate Setting

When modulation source is internal, the moving frequency between carrier wave phase and modulation phase can be set. After enabling PSK function, PSK rate can be set and the settable range is

2mHz to 100kHz, the default rate is 100Hz. If need to change, press **Carrier Wave Parameter** → **Rate** in turn.

Modulation Phase Setting

Modulation phase indicates the change between the phases of PSK modulated waveform and the phase of carrier wave phase. Settable range of PSK phase is from 0° to 360°, and the default value is 0°. If need to change, press **Parameter** → **Phase** in turn.

Comprehensive Example

Make the instrument work in phase shift keying (PSK) mode, then set a sine wave with 2kHz and 2Vpp from the internal of the instrument as a carrier wave signal, finally, make carrier wave phase and modulation phase move between each other with 1kHz frequency. Specific steps are seen as following:

1) Enable Phase Shift Keying (PSK) Function

Press **Menu** → **Modulation** → **Type** → **Phase Shift Keying** in turn to start the PSK function.

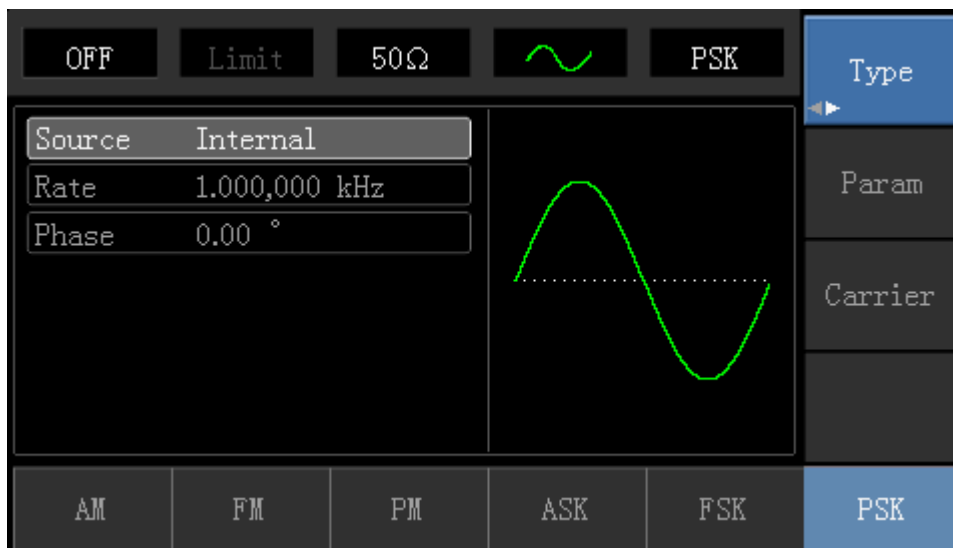

2) Set Carrier Wave Signal Parameter

Press **Carrier Wave Parameter** → **Type** → **Sine Wave** in turn to select sine wave as carrier wave signal.

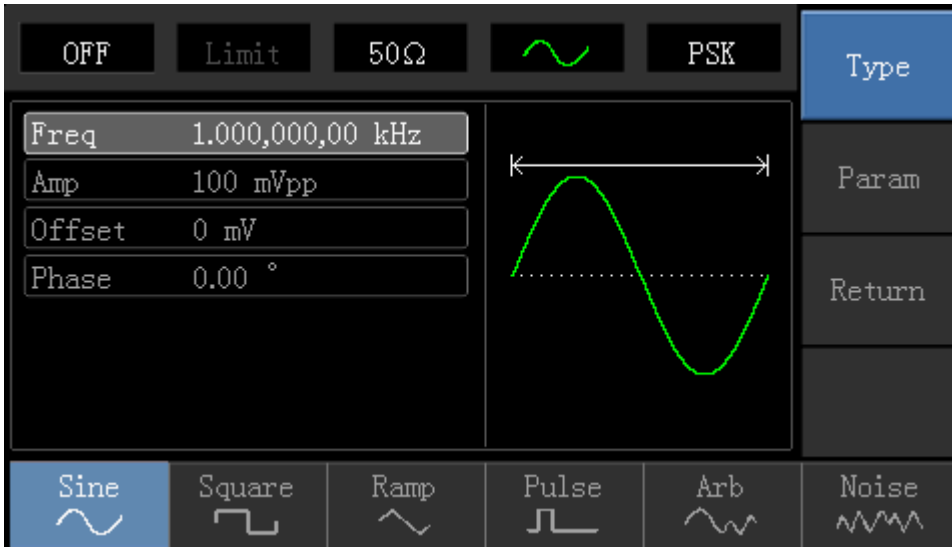

Press **Parameter** softkey, and the interface will pop up as following:

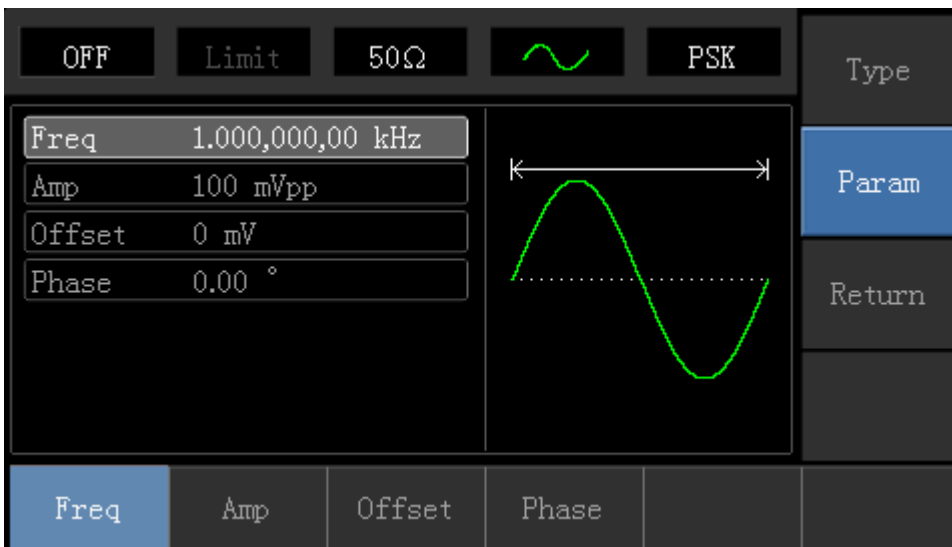

Press corresponding softkey, then enter required numerical value, and select the unit.

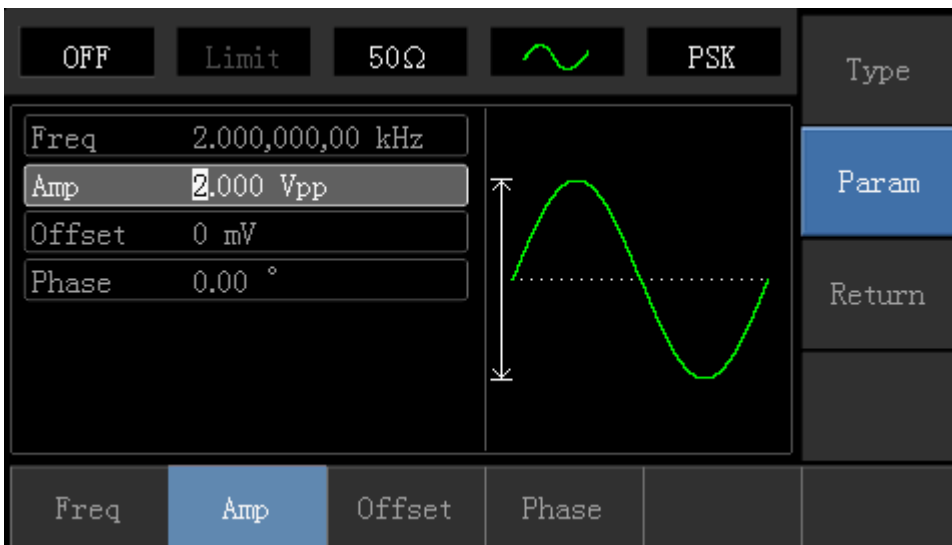

3) Set PSK Rate and Modulation Phase

Press **Return** softkey to go back to the following interface:

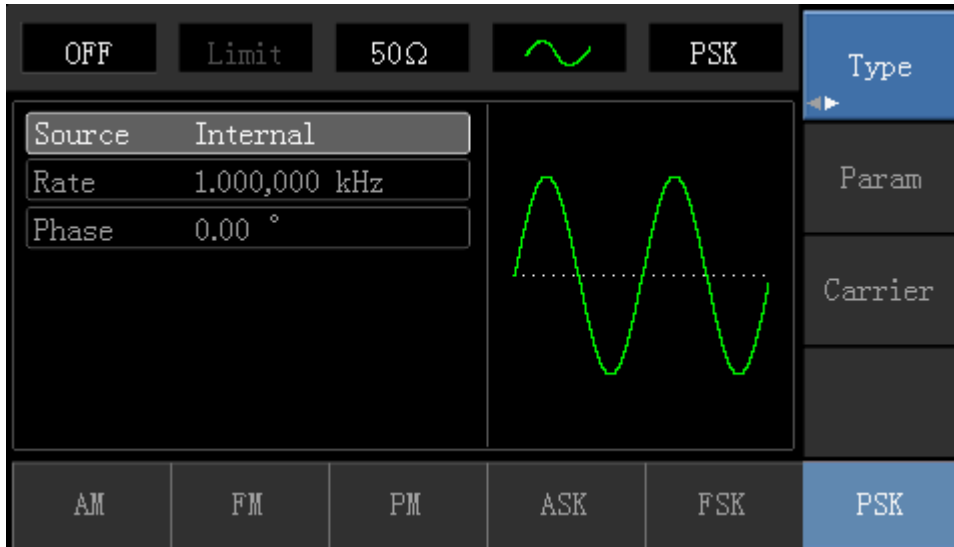

Press **Parameter** softkey, and the interface will pop up as following:

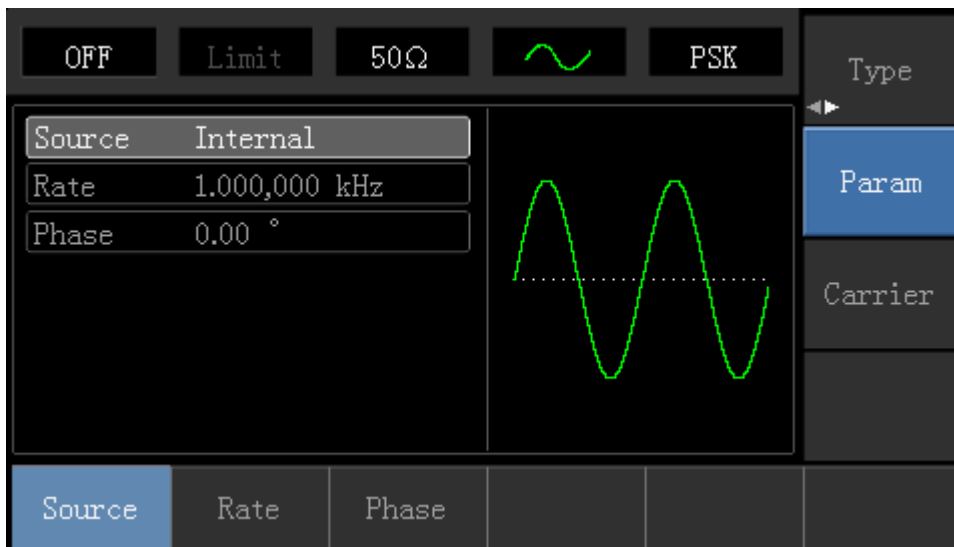

Press corresponding softkey, then enter required numerical value, and select the unit.

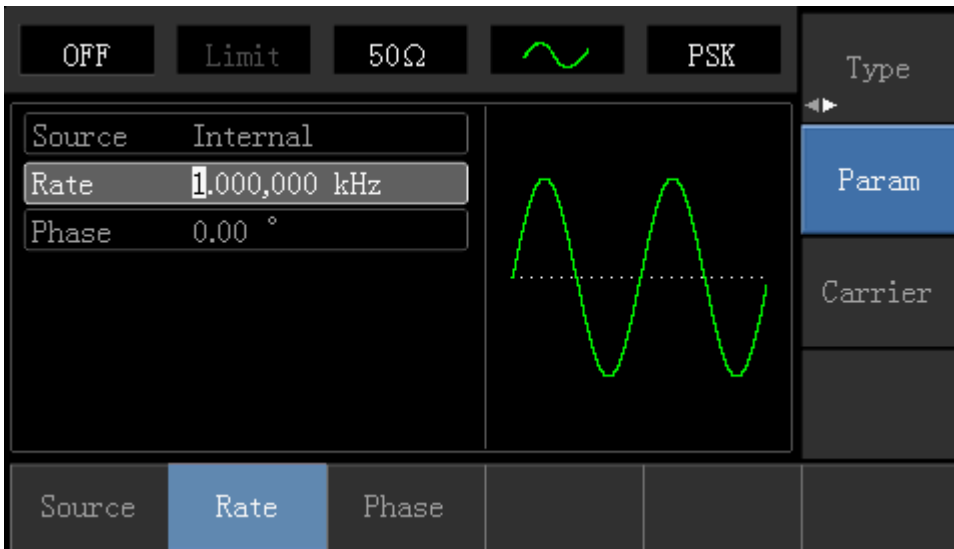

4) Enable Channel Output

Press Channel button to open channel output quickly.

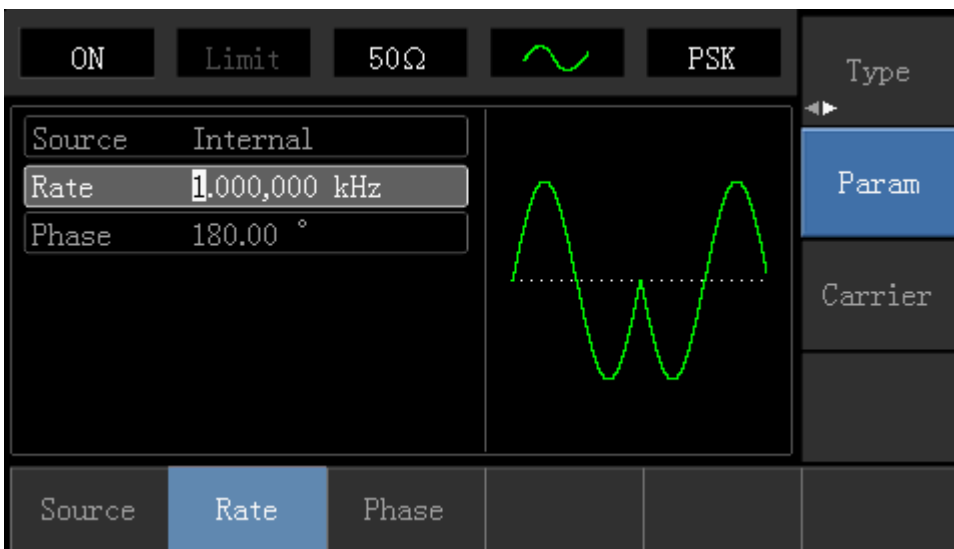

The shape of PSK modulation waveform checked through oscilloscope is shown as following:

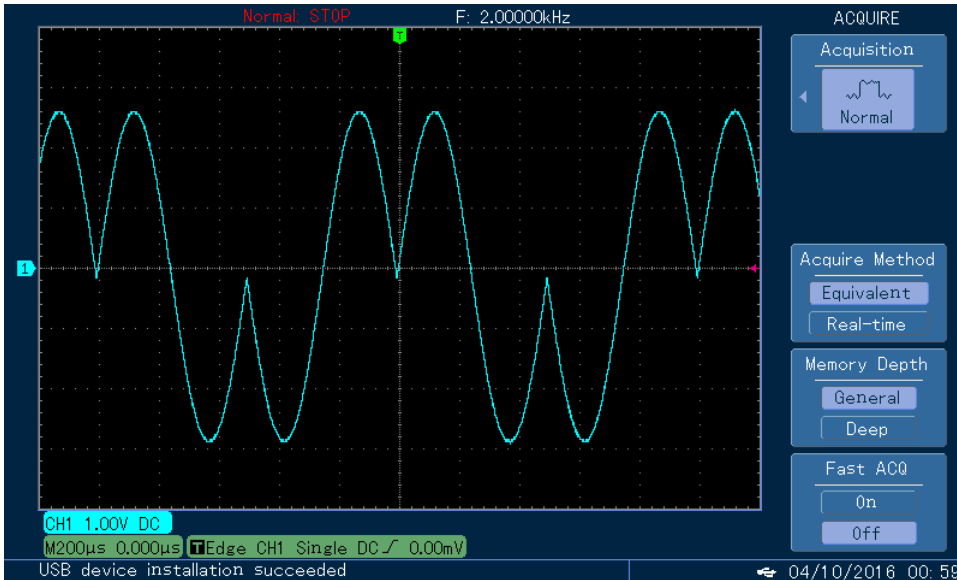

4.1.7 Pulse Width Modulation (PWM)

In pulse width modulation, modulated waveform is usually composed of carrier wave and modulation shape, and the pulse width of carrier wave will change as modulation shape amplitude changes.

PWM Modulation Selection

Press **Menu** → **Modulation** → **Type** → **Pulse Width Modulation** in turn to start the PWMK function. The device will output modulated waveform with modulation waveform and carrier wave of current setting.

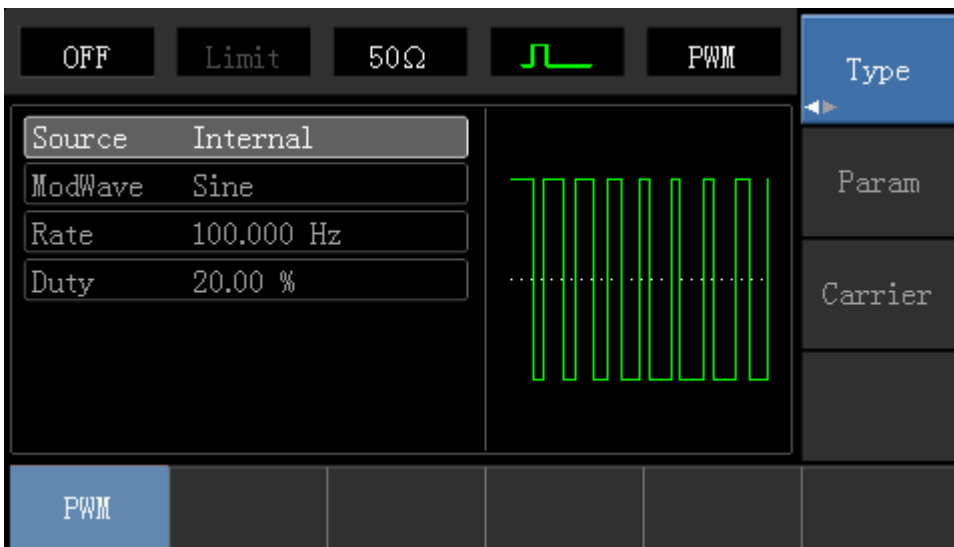

Carrier Wave Waveform

PWM carrier wave waveform can only be pulse wave. After PWM modulation, press **carrier parameter** softkey to enter carrier wave waveform selection interface, then it can be seen that **Pulse Wave** label is selected automatically.



Carrier Wave Frequency Setting

Settable range of pulse wave frequency is from 500uH to 25MHz, and the default frequency is 1kHz. Press **Parameter** → **Frequency** softkey to change frequency, then enter required numerical value, and select unit.

Carrier Wave Duty Cycle Setting

Settable range of pulse wave duty cycle is 0.01%~99.99%, and the default duty cycle is 50%. Press **Parameter** → **Frequency** softkey to change, then enter required numerical value, and select unit.

Modulation Source Selection

The device can select internal modulation source or external modulation source. If need to change, press **Parameter** → **ModulationSource** → **External** in turn.

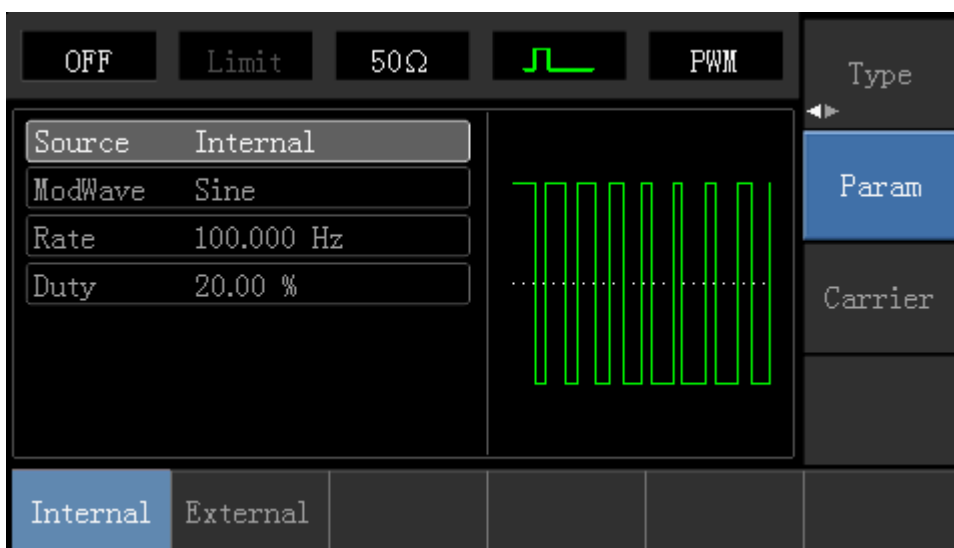

1) Internal Source

When modulation source is internal, modulation wave can be: sine wave, square wave, rising ramp wave, falling ramp wave, arbitrary wave and noise, and the default wave is sine wave. If need to change, press **Carrier Wave Parameter**→**Modulation Waveform** in turn.

- Square wave: duty cycle 50%
- Lead Ramp Wave: symmetry degree is 100%
- Tail Ramp Wave: symmetry degree is 0%
- Arbitrary Wave: Arbitrary wave length limit is 1kpts
- Noise: White Gauss noise

2) External Source

When modulation source is external, carrier wave waveform will be modulated by an external waveform.

Modulation Shape Frequency Setting

When modulation source is internal, frequency of modulation wave can be modulated (range is 2mHz~20kHz). After enabling PWM function, the default of modulation wave frequency is 1kHz. If need to change, press **Carrier Wave Parameter**→**Modulation Frequency** in turn. When modulation source is external, carrier wave waveform (pulse wave) will be modulated by an external waveform. The range of modulation signal input from external is 0Hz to 20kHz.

Duty Cycle Deviation Setting

The duty cycle deviation represents the difference between the duty cycle of the modulated waveform and the current carrier's duty cycle. Settable range of PWM duty cycle is from 0% to 49.99%, and the default value is 20%. If need to change, press **Parameter**→**Duty Cycle Deviation** in turn.

- The duty cycle deviation represents the difference between the duty cycle of the modulated waveform and the duty cycle of the original pulse waveform, represented in %.
- Duty cycle deviation cannot be beyond the duty cycle of current pulse wave.
- Sum of duty cycle deviation and the current pulse wave duty cycle must no more than 99.99%.
- Duty cycle deviation is limited by the minimal duty cycle of pulse wave and current edge time.

Comprehensive Example

Make the instrument work in pulse modulation (PWM) mode, then set a sine wave with 1kHz from the internal of the instrument as a modulation signal and a pulse wave with 10kHz frequency, 2Vpp amplitude and 50% duty cycle as a carrier wave signal, finally, set duty cycle deviation to 40%. Specific steps are seen as following:

1) Enable Pulse Width Modulation (PWM) Function

Press **Menu**→**Modulation**→**Type**→**Pulse Width Modulation** in turn to start the PWM function.

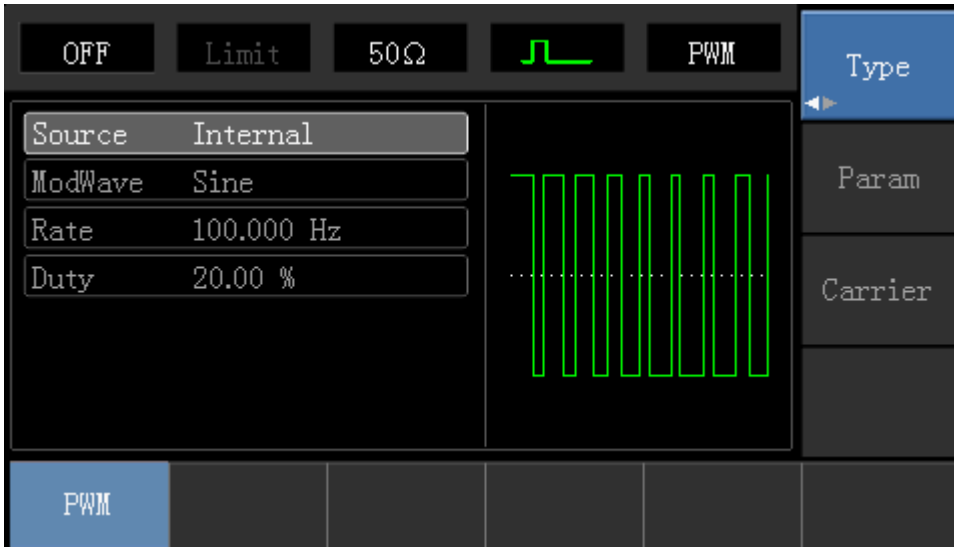

2) Set Modulation Signal Parameter

Press **Parameter** softkey and the interface will show as following:

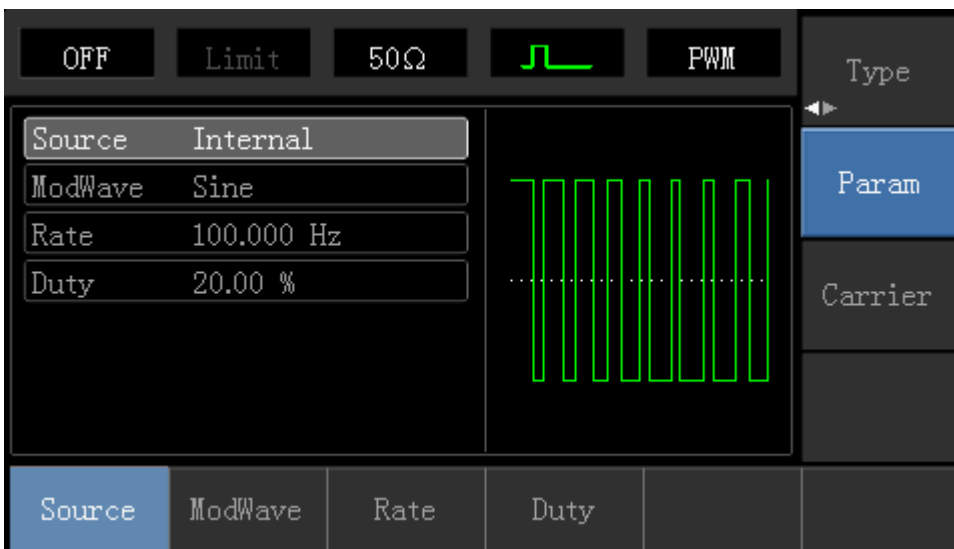

Press corresponding softkey, then enter required numerical value, and select the unit.

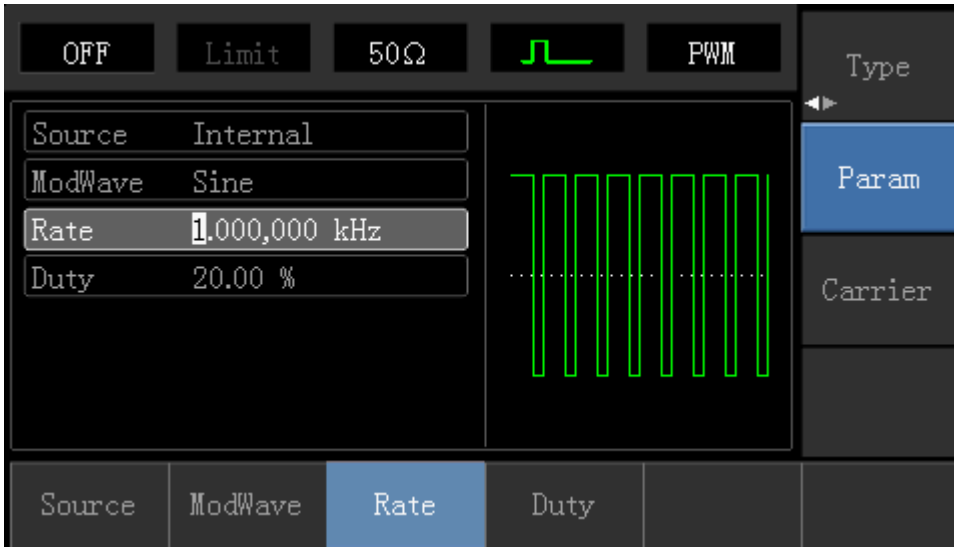

3) Set Carrier Wave Signal Parameter

Press **Carrier Wave Parameter** softkey to enter carrier wave parameter setting interface.



Press **Parameter** softkey, and the interface will pop up as following:



If need to set parameter, press corresponding softkey first, then enter required numerical value, and select the unit.

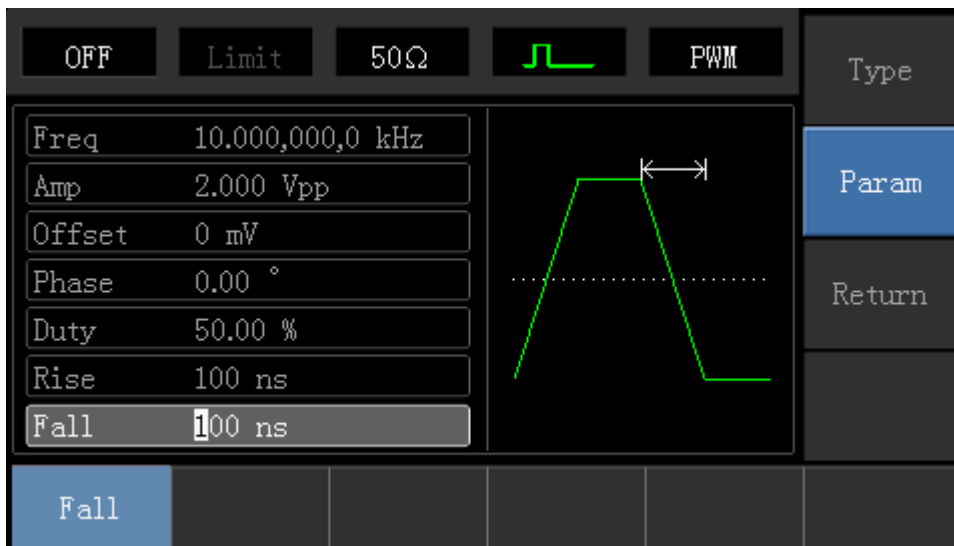

4) Set Duty Cycle Deviation

Press Return softkey to back to the following interface for duty cycle deviation setting:

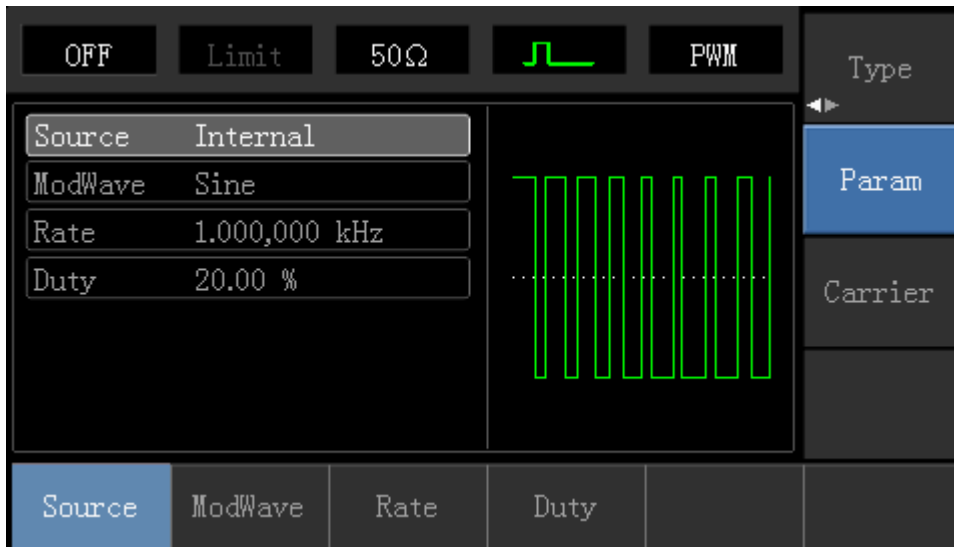

After pressing **Parameter** → **Dutycycle** softkey, enter number 40 and press **%** softkey with number keyboard for setting duty cycle deviation.

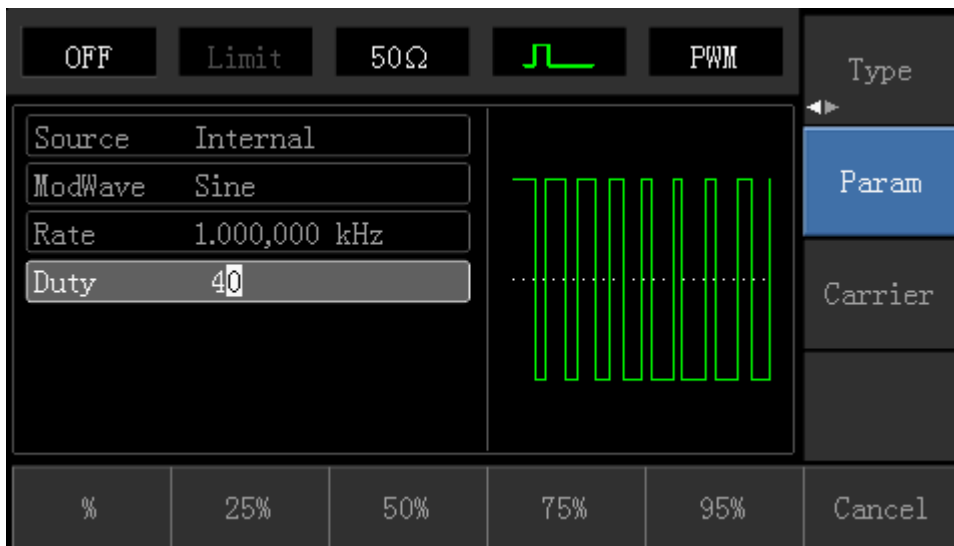

5) Enable Channel Output

Press Channel button to open channel output quickly.

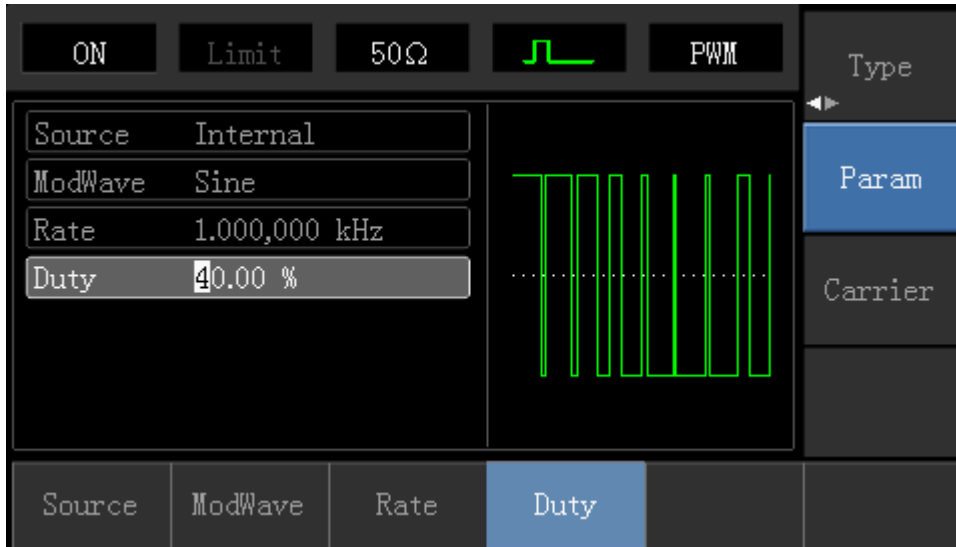

The shape of PWM modulation waveform checked through oscilloscope is shown as following:

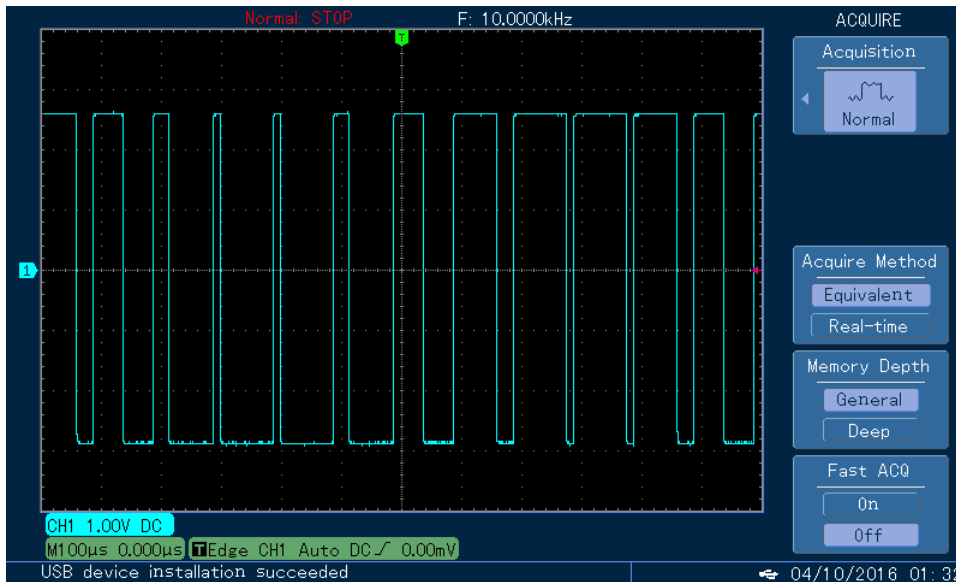

4.2 Sweep Waveform Output

In sweep mode, frequency is output in linear or logarithmic way during the specified sweep time. Trigger source can be internal, external or manual trigger; and sine wave, square wave, ramp wave and arbitrary wave (except DC) can produce sweep output.

4.2.1 Sweep Selection

1) Enable Sweep Function

Press **Menu** button first, then press **Sweep** softkey to start sweep function. The device will output sweep waveform with current setting.

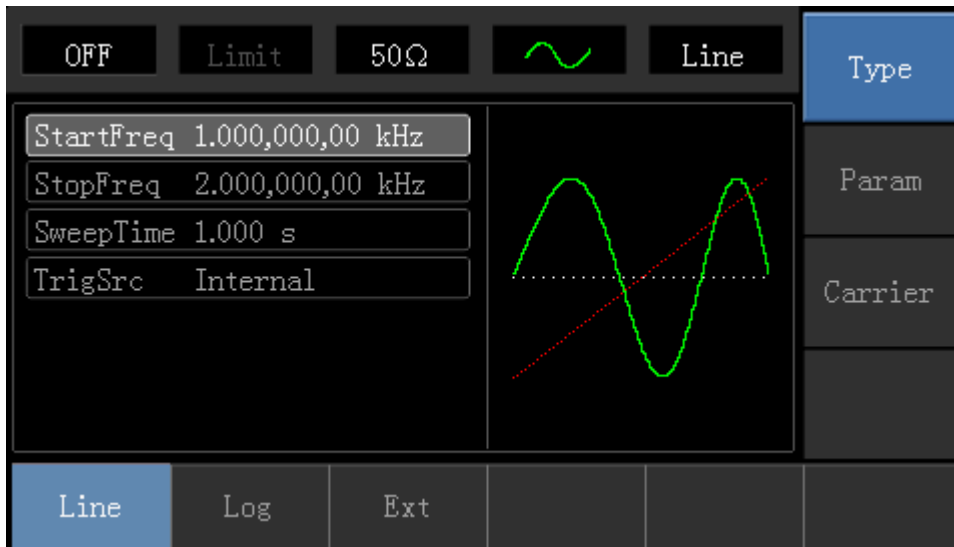

2) Sweep Waveform Selection

Press **Carrier Parameter** softkey to select sweep waveform, then the interface popping up will show as following:

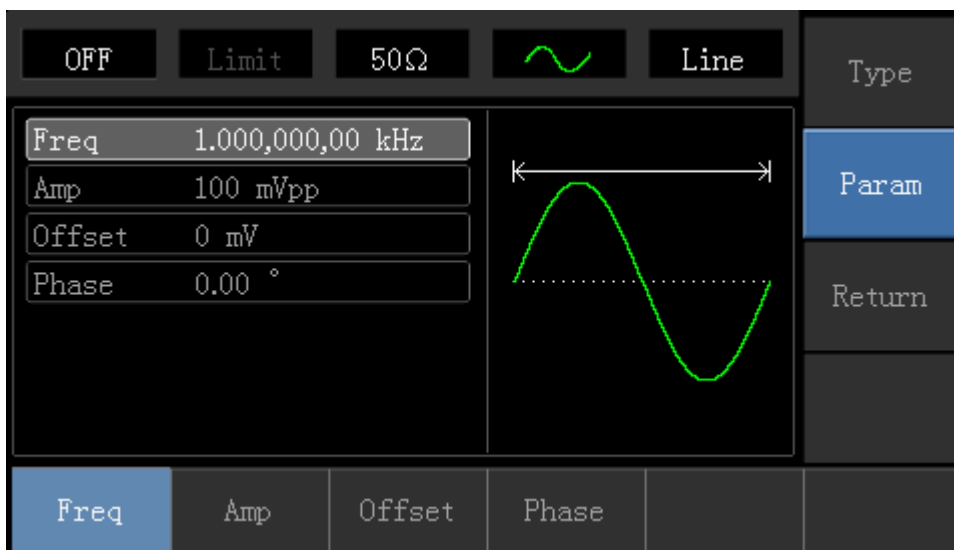

4.2.2 Start Frequency and Stop Frequency Setting

Start frequency and stop frequency are the upper limit and lower limit of frequency scanning. Press **Return** softkey to back to sweep interface. Press **Parameter** → **Start Frequency** → **StopFrequency** softkeys in turn, then enter number with number keyboard and press corresponding unit softkey.

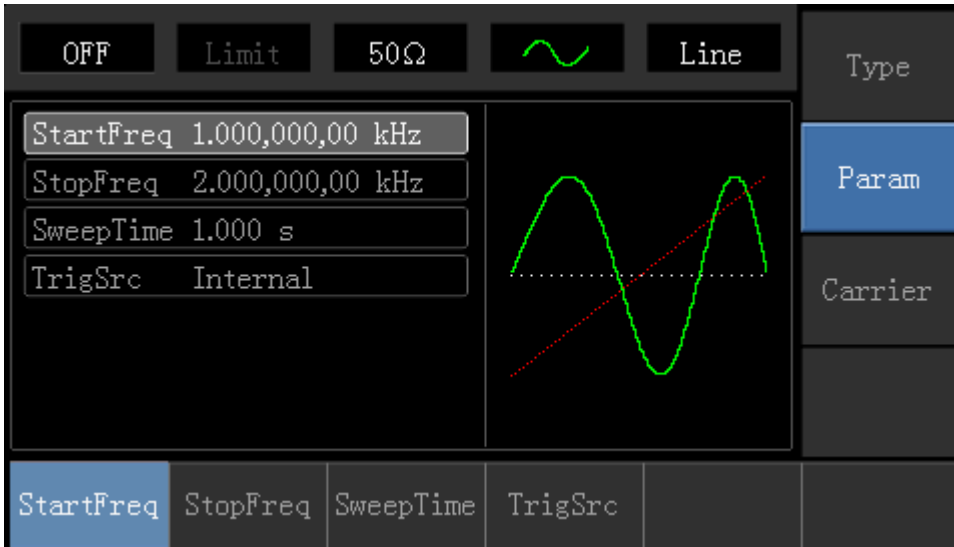

- If start frequency is lower than stop frequency, DDS function generator sweeps from low frequency to high frequency.
- If start frequency is higher than stop frequency, DDS function generator sweeps from high frequency to low frequency.
- If start frequency is equivalent to stop frequency, DDS function generator sweeps output fixed frequency.
- **Synchronous signal of sweep mode is a signal that is low from the start of sweep time to the middle of sweep time, and is high from the middle of sweep time to the end of sweep time.**

The default of start frequency is 1kHz, and stop frequency is 2kHz. Different sweep waveform has different settable range of enabling and stop frequency, settable frequency range of each sweep wave are shown in the following table:

Carrier Wave Waveform	Frequency			
	UTG1010A		UTG1005A	
	Minimum Value	Maximum Value	Minimum Value	Maximum Value
Sine Wave	1μHz	10MHz	1μHz	5MHz
Square Wave	1μHz	5MHz	1μHz	5MHz
Ramp Wave	1μHz	400kHz	1μHz	400KHz
Arbitrary Wave	1μHz	2MHz	1μHz	1MHz

4.2.3 Sweep Mode

Linear sweep: waveform generator changes output frequency in the linear way during the sweep;
 Logarithmic sweep: waveform generator changes output frequency in logarithmic way; External sweep,
 the default is linear sweep way, if need to change, please press **Type** **Logarithm** softkey.

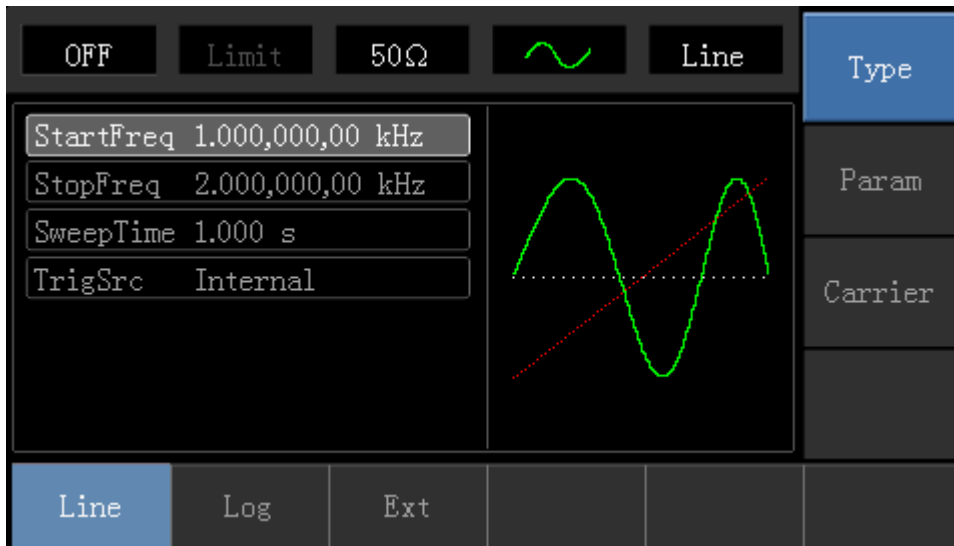

4.2.4 Sweep Time

Set the required time from initial frequency to terminal frequency, the default is 1s, and the settable range is from 1ms to 500s. If need to change, press **Parameter** → **Sweep Time** softkey in turn, then enter number with number keyboard, and press corresponding unit softkey

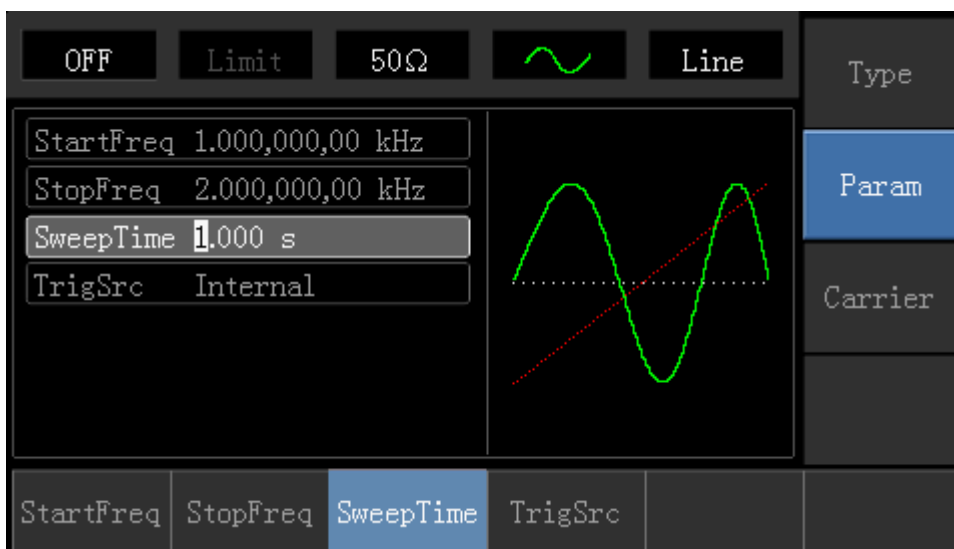

4.2.5 Trigger Source Selection

When signal generator receives a trigger signal, it generates a sweep output, and then waits for the next trigger signal. Sweep source can be internal, external or manual trigger. If need to change, press **Parameter** → **Trigger Source** softkey in turn.

- 1) When internal trigger is selected, waveform generator will output a continuous sweep, and the rate

is determined by sweep time.

- When external trigger is selected, waveform generator will trigger through modulation interface hardware.

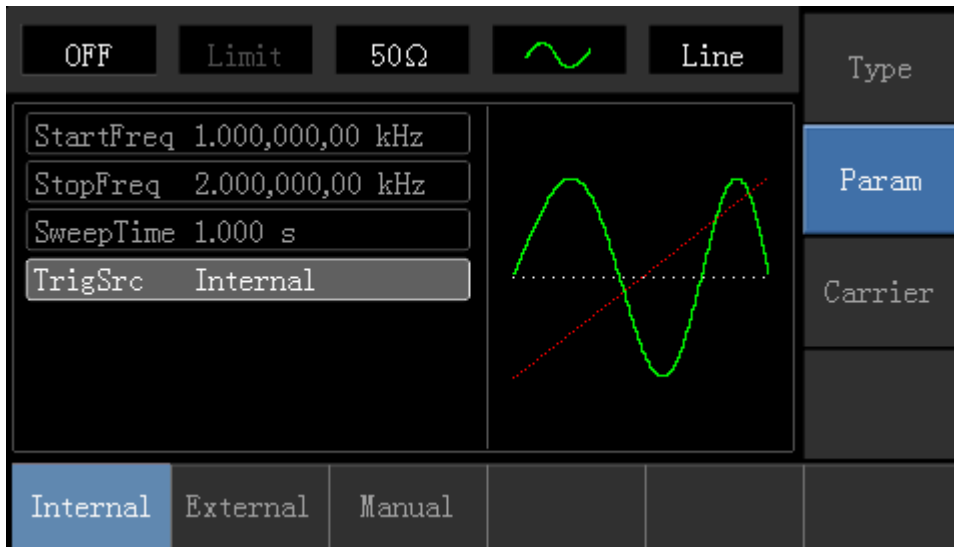

- When manual trigger is selected, backlight of **Trigger** button will flash, press **Trigger** button for once, sweep will be output.

4.2.6 Trigger Output

When trigger source is internal or manual trigger, trigger signal (square wave) can be output through external modulation interface (Input/CNT probe). The default of trigger output option is “Close”. If need to change, press **Parameter** → **Trigger Output** → **Open** softkey in turn.

- In internal trigger, signal generator output a square of 50% duty cycle through external modulation interface (Input/CNT probe) at the beginning of sweep.
- In manual trigger, signal generator output a pulse that has pulse width more than 1us through external modulation interface (Input/CNT probe) at the beginning of sweep.
- In external trigger, trigger output is output through modulation interface (Input/CNT probe), but trigger output options in parameter list will be hid.

4.2.7 Comprehensive Example

In sweep mode, set a sine wave signal with 1Vpp amplitude and 50% duty cycle as sweep signal, and sweep way is linear sweep, set the initial frequency of sweep to 1kHz and terminal frequency to 50kHz and sweep time to 2ms. Use rising edge trigger of internal source to to output sweep wave. Specific steps are seen as following:

- Enable Sweep Function

Press **Menu** → **Sweep** → **Type** → **Linear** in turn to start the Sweep function.

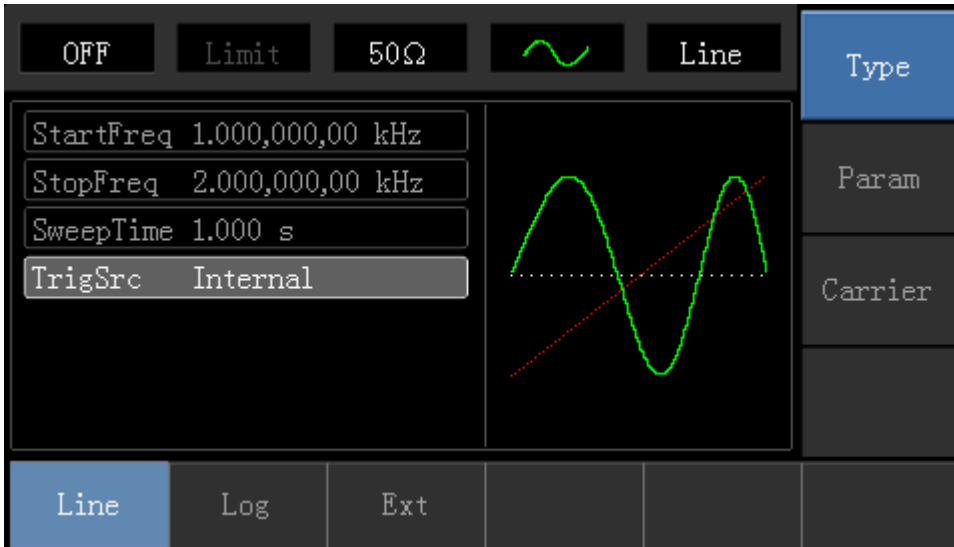

2) Select Sweep Waveform

Press **Carrier Wave Parameter** → **Type** → **Square Wave** softkey to select sweep waveform, and the interface will pop up as following:

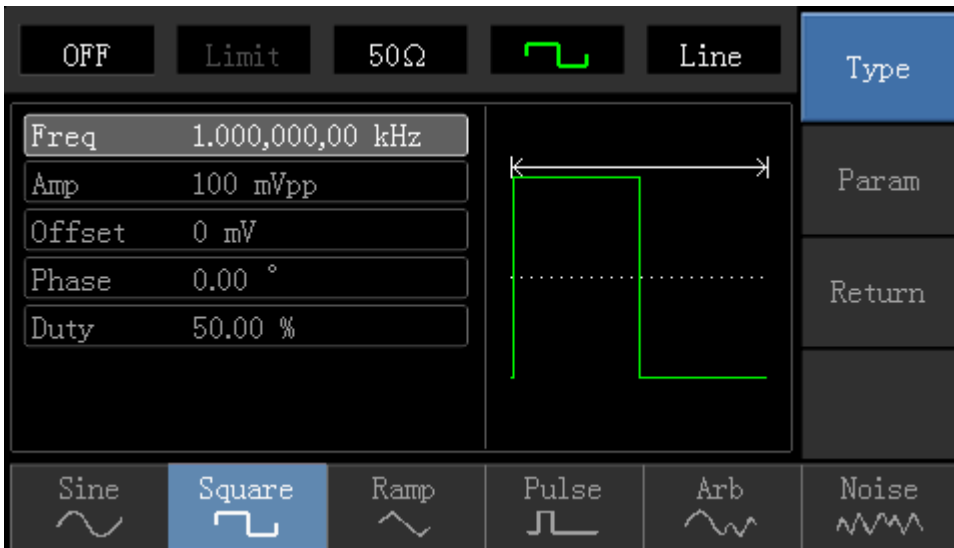

Press **Parameter** softkey, and the interface will pop up as following:



Press corresponding softkey, then enter required numerical value, and select the unit.

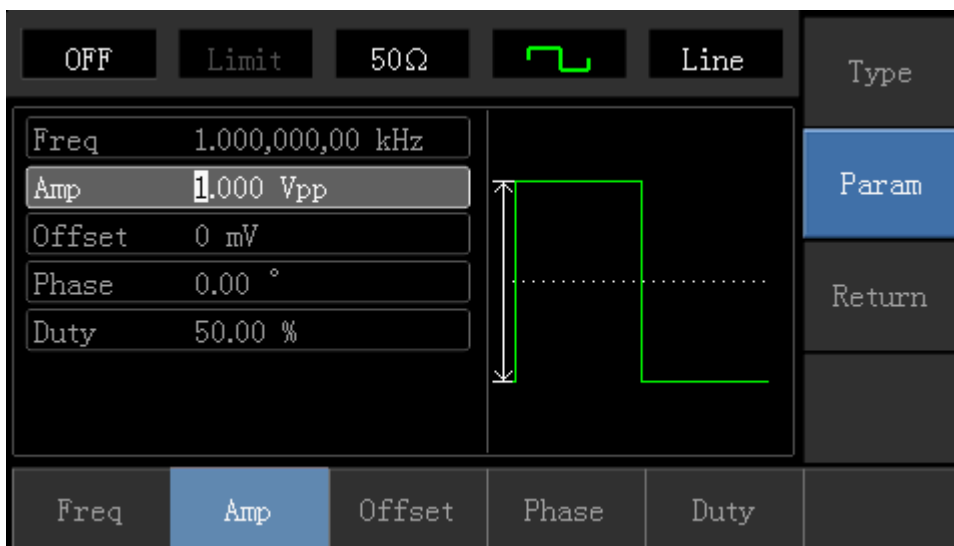

3) Set Initial/Terminal Frequency, Sweep Time, Trigger Source and Trigger Edge
 Press **Return** softkey to the following interface:

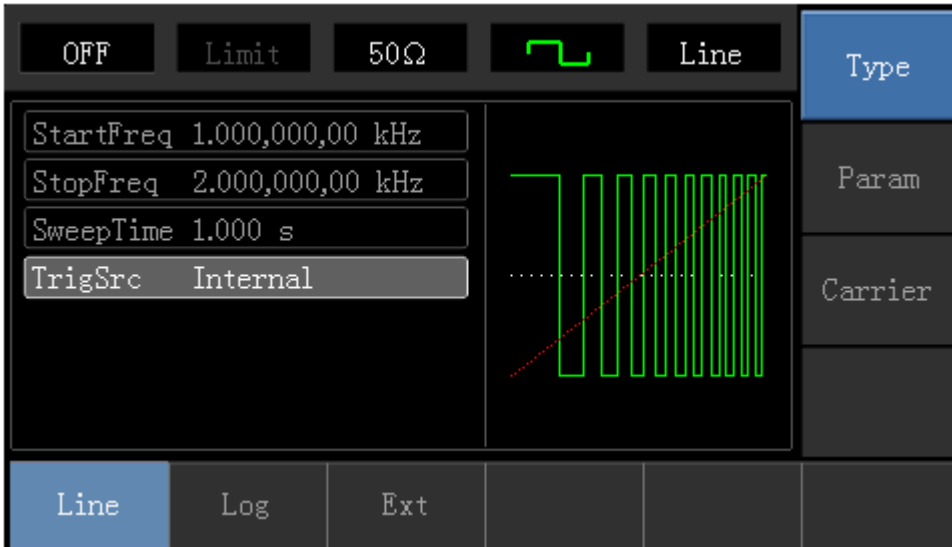

Press **Parameter** softkey, and the interface will pop up as following:

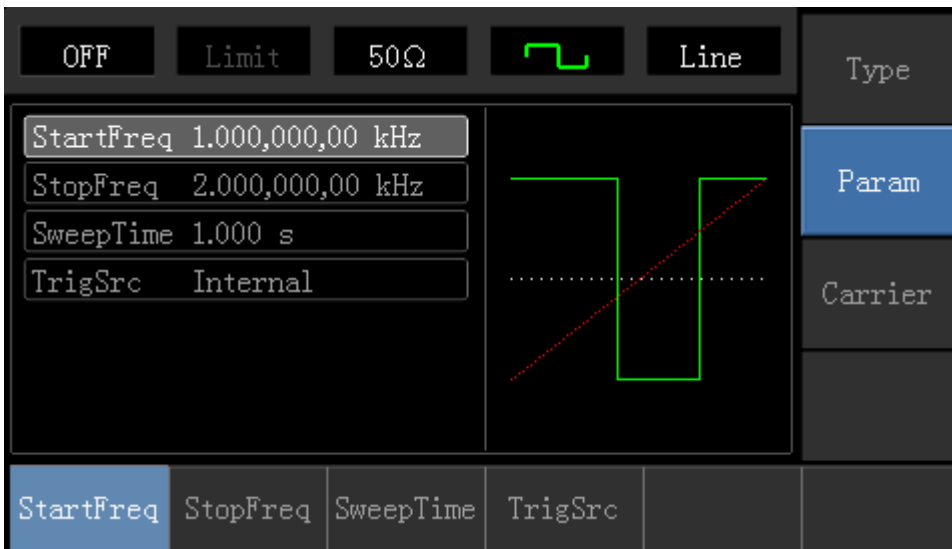

Press corresponding softkey, then enter required numerical value, and select the unit.

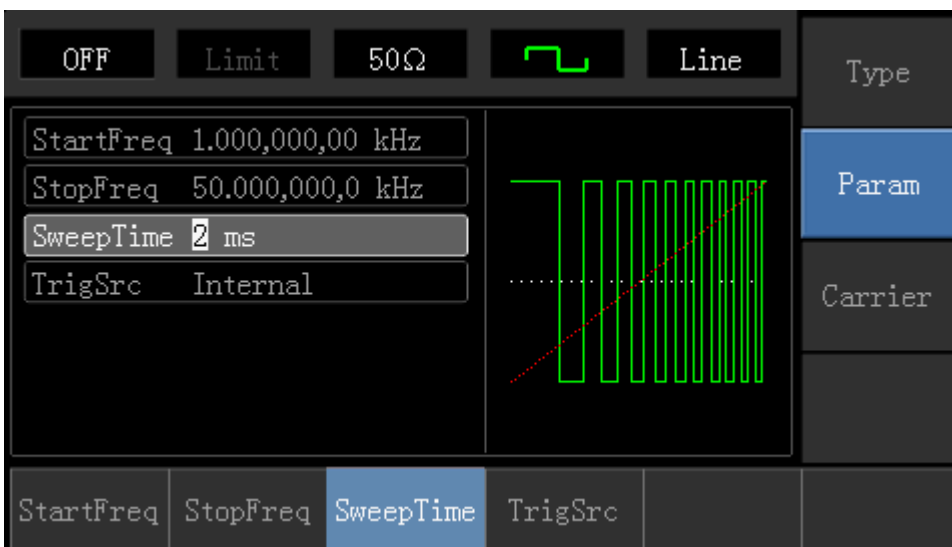

4) Enable Channel Output

Press Channel button to open channel output quickly.

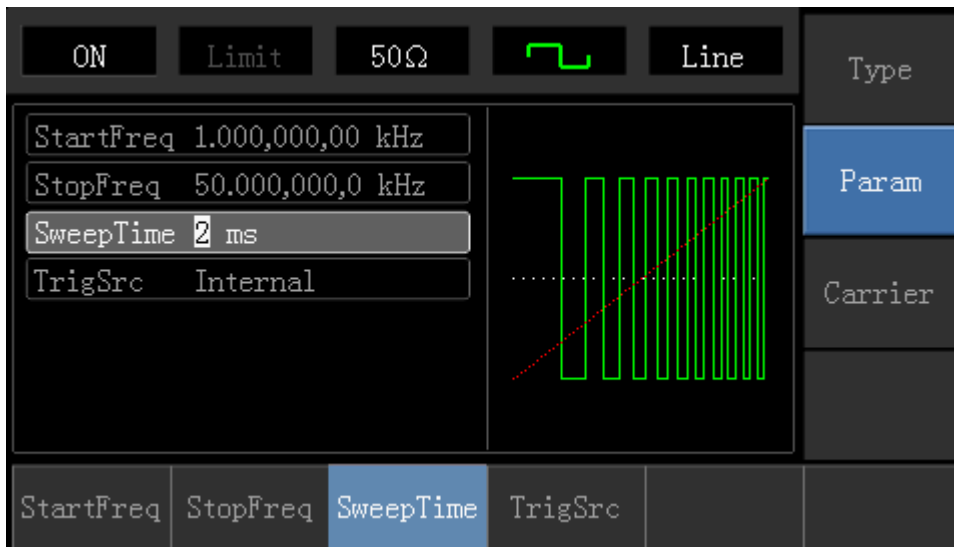

The shape of sweep waveform checked through oscilloscope is shown as following:

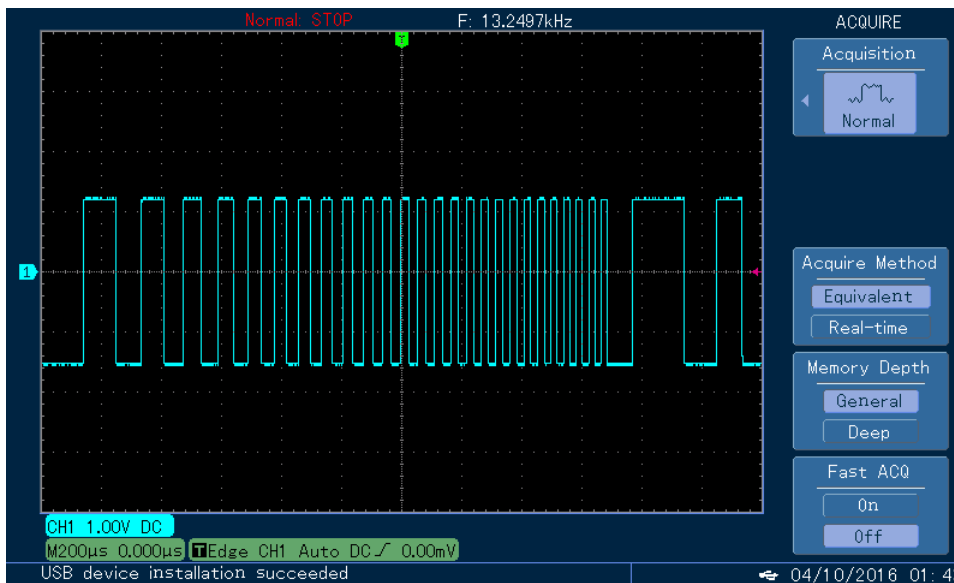

4.3 Arbitrary Wave Output

UTG1000A stores totally 16 types of standard waveforms, names of each waveform can be found in table 4-1 (built-in arbitrary wave list).

4.3.1 Enable Arbitrary Wave Function

Press **Menu** → **Waveform** → **Type** → **Arbitrary Wave** in turn to start the arbitrary wave function. The device will output arbitrary waveform with current setting.

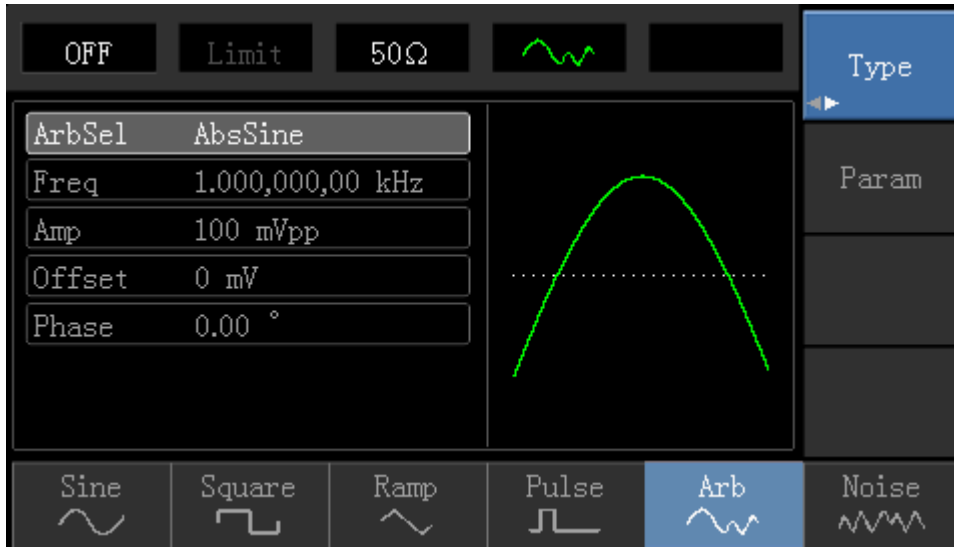

4.3.2 Arbitrary Wave Selection

Users can select arbitrary waveform in the internal of instrument. Press **Parameter** → **Arbitrary Wave Selection** softkey to select required arbitrary wave.

Table 4-1 Built-in Arbitrary Wave List

AbsSine	AmpALT	AttALT	Gaussian Monopulse
GaussPulse	SineVer	StairUd	Trapezia
LogNormalSinc	Sinc	Electrocardiogram	Electroencephalogram
Index Rises	Index Falls	Lorentz	D-Lorentz

Chapter 5 Trouble Shooting

Possible troubles and trouble shooting methods are listed in following. Please follow the steps to handle problems. If you cannot handle them, please contact distributors of this product or local office, and also provide the equipment informations of your instrument (acquisition method: press **Utility** → **System** → **System** → **About** in turn).

5.1 No Display On Screen (Black Screen)

When the power button is pressed and the oscilloscope is black screen:

- a) Check the power supply connection
- b) Make sure the power switch on the rear panel is on and is set to "I"
- c) Make sure the power switch of front panel is on
- d) Restart the instrument

5.2 No Waveform Output

After signal acquisition, waveform does not appear on display:

- ① Check if the BNC cable is connected to the channel output
- ② Check if the pressing button Channel is open

Chapter 6 Services and Supports

6.1 Warranty Overview

Uni-T (Uni-Trend Technology (China) Ltd.) ensures the production and sale of products, from authorized dealer's delivery date of three years, without any defects in materials and workmanship. If the product is proven to be defective within this period, UNI-T will repair or replace the product in accordance with the detailed provisions of the warranty.

To arrange for repair or acquire warranty form, please contact the nearest UNI-T sales and repair department.

In addition to permit provided by this summary or other applicable insurance guarantee, Uni-T does not provide any other explicit or implied guarantee, including but not limited to the product trading and special purpose for any implied warranties. In any case, UNI-T for indirect, special, or consequential loss does not bear any responsibility.

6.2 Contact Us

If the use of this product has caused any inconvenience, you can contact Uni-Trend Technology (China) Limited directly in mainland China or your local UNI-T dealer or sales center.

Many of the products that support UNI-T have an extended the warranty period plan and a calibration period, please contact your local UNI-T dealer or sales center.

To obtain the address list of our service centers, please visit our website at URL:
<http://www.uni-trend.com>

Appendix A Factory Reset State

Parameters	Factory Defaults
Channel Parameters	
Current Carrier Wave	Sine Wave
Output Outload	50Ω
Synchronous Output	Channel
Channel Output	Close
Channel Output Invert	Close
Amplitude Limit	Close
Amplitude Upper Limit	+5V
Amplitude Lower Limit	-5V
Basic Wave	
Frequency	1kHz
Amplitude	100mVpp
DC Offset	0mV
Initial Phase	0°
Duty Cycle of Square Wave	50%
Symmetry of Ramp Wave	100%
Duty Cycle of Pulse Wave	50%
Lead Edge of Pulse Wave	24ns
Tail Edge of Pulse Wave	24ns
Arbitrary Wave	
Built-in Arbitrary Wave	AbsSine
AM Modulation	
Modulation Source	Internal
Modulation Shape	Sine Wave
Modulation Frequency	100Hz
Modulation Depth	100%
FM Modulation	
Modulation Source	Internal

Modulation Shape	Sine Wave
Modulation Frequency	100Hz
Fequency Offset	1kHz
PM Modulation	
Modulation Source	Internal
Modulation Shape	Sine Wave
Modulation Phase Frequency	100Hz
Phase Offset	180°
PWM Modulation	
Modulation Source	Internal
Modulation Shape	Pulse Wave
Modulation Frequency	100Hz
Duty Cycle Deviation	20%
ASK Modulation	
Modulation Source	Internal
ASKRate	100Hz
FSK Modulation	
Modulation Source	Internal
Carrier Wave Frequency	1kHz
Hop Frequency	2MHz
FSKRate	100Hz
PSK Modulation	
Modulation Source	Internal
PSK Rate	100Hz
PSK Phase	180°
Sweep	
Sweep Type	Linear
Initial Frequency	1kHz
TerminalFrequency	2kHz

Sweep Time	1s
Trigger Source	Internal
Parameters of System	
Sound of Buzzer	Open
Number Format	,
Backlight	100%
Language*	Determined by Factory Settings

Appendix B Technical Specifications

Type	UTG1010A	UTG1005A
Channel	Single Channel	Single Channel
Max. Frequency	10MHz	5MHz
Sample Rate	125MSa/s	125MSa/s
Waveform	Sine Wave, Square Wave, Triangle Wave, Pulse Wave, Ramp Wave, Noise, DC, Arbitrary Waveform	
Working Mode	Output Strobe, Duration, Modulation, Scanning	
Modulation Type	AM、FM、PM、ASK、FSK、PSK、PWM	
Features of Waveform		
Sine Wave		
Frequency Range	1μHz~10MHz	1μHz~5MHz
Resolution	1μHz	
Accuracy	±50ppm in 90 days, ±100ppm in one year (18°C~28°C)	
Harmonic Distortion (Typical Value)	Test Condition: output power 0dBm	
	-55dBc	
	-50dBc	
	-40dBc	
Total Harmonic Distortion (Typical Value)	DC~20kHz, 1Vpp<0.2%	
Square Wave		
Frequency Range	1μHz~5MHz	1μHz~5MHz
Resolution	1μHz	
Lead/Tail Time	<24ns (typical value, 1kHz, 1Vpp)	
Overshoot (Typical Value)	<2%	
Duty Cycle	0.01%~99.99%	

Min.Pulse	≥80ns	
Jittering (Typical Value)	1ns+ 100ppm of period	
Ramp Wave		
Frequency Range	1μHz~400kHz	
Resolution	1μHz	
Nonlinear Degree	1%±2 mV (typical value, 1kHz, 1Vpp, symmetry 50%)	
Symmetry	0.0% to 100.0%	
Min. Edge Time	≥400ns	
Pulse Wave		
Frequency Range	1μHz~5MHz	1μHz~5MHz
Resolution	1μHz	
Pulse Eidth	≥80ns	
Lead/Tail Time	<24ns (typical value, 1kHz, 1Vpp)	
Overshoot (Typical Value)	<2%	
Jittering (Typical Value)	1ns+ 100ppm of period	
DC Offset		
Range (Peak Value AC+DC)	±5V (50Ω)	
	±10V (High Resistance)	
Offset Precision	± (1% of offset setting +0.5% of ampltide +2mV)	
Features of Arbitrary Waveform		
Frequency Range	1μHz~2MHz	1μHz~1MHz
Resolution	1μHz	
Waveform Length	2048 points	
Vertical Resolution	14bits (including symbols)	
Sample Rate	125MSa/s	
Non-volatile Memory	16 types of waveform	
Output Features		
Amplitude Range	1mVpp~10Vpp	1mVpp~10Vpp

	(50Ω)	(50Ω)
	2mVpp~20Vpp (high resistance)	2mVpp~20Vpp (high resistance)
Accuracy (Sine wave of 1kHz)	1% of amplitude setting value ±2 mV	
Amplitude Flatness (relative to sine wave of 1kHz, 1Vpp/50Ω)	<100kHz	0.1dB
	100kHz~10MHz	0.2dB
Waveform Output		
Impedance	Typical value of 50Ω	
Insulation	To earth wire, max.42Vpk	
Protection	Short-circuit Protection	
Modulation Type		
AM Modulation		
Carrier Wave	Sine Wave, Square Wave, Ramp Wave, Arbitrary Wave	
Source	Internal/External	
Modulation Shape	Sine Wave, Square Wave, Ramp Wave, Noise, Arbitrary Wave	
Modulation Frequency	2mHz~50kHz	
Modulation Depth	0%~120%	
FM Modulation		
Carrier Wave	Sine Wave, Square Wave, Ramp Wave,Arbitrary Wave	
Source	Internal/External	
Modulation Shape	Sine Wave, Square Wave, Ramp Wave, Noise, Arbitrary Wave	
Modulation Frequency	2mHz~50kHz	
Frequency Offset	1μHz~5MHz	1μHz~2.5MHz
PM Modulation		
Carrier Wave	Sine Wave, Square Wave, Ramp Wave,	

	Arbitrary Wave
Source	Internal/External
Modulation Shape	Sine Wave, Square Wave, Ramp Wave, Noise, Arbitrary Wave
Modulation Frequency	2mHz~50kHz
Phase Offset	0°~360°
ASK Modulation	
Carrier Wave	Sine Wave, Square Wave, Ramp Wave, Arbitrary Wave
Source	Internal/External
Modulation Shape	Square Wave of 50% duty cycle
Modulation Frequency	2mHz~100kHz
FSK Modulation	
Carrier Wave	Sine Wave, Square Wave, Ramp Wave, Arbitrary Wave
Source	Internal/External
Modulation Shape	Square Wave of 50% duty cycle
Modulation Frequency	2mHz~100kHz
PSK Modulation	
Carrier Wave	Sine Wave, Square Wave, Ramp Wave, Arbitrary Wave
Source	Internal/External
Modulation Shape	Square wave of 50% duty cycle
Modulation Frequency	2mHz~100kHz
PWM Modulation	
Carrier Wave	Pulse Wave
Source	Internal/External
Modulation Shape	Sine Wave, Square Wave, Ramp Wave, Noise, Arbitrary Wave
Modulation Frequency	2mHz~50kHz

Width Deviation	0%~49.99% of pulse width	
Sweep		
Carrier Wave	Sine Wave, Square Wave, Ramp Wave	
Type	Linearity, Logarithm	
Sweep Time	1ms~500s±0.1%	
Trigger Source	Manual, Internal, External	
Synchronous Signal		
Output Level	TTL compatible	
Output Frequency	1μHz~10MHz	1μHz~5MHz
Output Resistance	50Ω, typical value	
Coupled Mode	Direct Current	
Front Panel Connector		
Modulation Input	±5Vpk during the whole measurement	
	20kΩ of input resistance	
Trigger Output	TTL compatible	
Frequency Meter Input	TTL compatible	
Frequency Meter		
Input Level	TTL compatible	
Input Frequency Range	1Hz~100MHz	
Accuracy	±51ppm	
Frequency Resolution	6 bit/s	
Coupled Mode	Direct Current	
General Technical Specifications		
Display		
Display Type	4.3 inch of TFT liquid crystal display	
Display Resolution	480 horizontal ×272 vertical	
Power		
Power Voltage	100~240 VAC, 45~440Hz, CAT II	
Consume Power	Less than 25W	
Fuse	2A, T Level, 250V	

Environment	
Temperature Range	Operation: 10°C~+40°C
	Non operation: -20°C~+60°C
Cooling Method	Fan cooling
Humidity Range	+35°C below: ≤90% relative humidity
	+35°C~+40°C: ≤60% relative humidity
Altitude	Operation: below 2000 meters
	Non Operation: below 15000 meters
Machine Specifications	
Size (Reference Data)	165mm×320mm×110mm
Net Weight	3.10kg
Gross Weight	4.10kg

Appendix C Accessories List

Type	UTG1000A
Standard Accessories	Power line meets local country standard
	USB data cable (UT-D06)
	BNC cable (1 meter)
	User CD
	Warranty card

Appendix D Maintenance and Cleaning

General Maintenance

- Do not store or place the instrument and liquid crystal display in direct sunlight.
- To avoid damaging instrument or probe, do not spray fog, liquid or solvent on the instrument or probe.

Cleaning and Maintenance

- Clean the the instrument according to the using situation.
- Please disconnect the power supply, then with a damp but not dripping soft cloth, wipe the instrument (it is suitable to use mild cleaning agent or water to wipe the dust on instrument, do not use chemistry or cleaning agent with potent substances like benzene, toluene, xylene, acetone, etc.) to wipe the dust off probes and the instrument.
- When cleaning the LCD screen, please pay attention and protect the LCD screen.
- Do not use any chemical abrasive cleaning agent on the instrument.

Warning: Please confirm that the instrument is completely dry before use, to avoid damage and personal injury caused by electrical short circuit caused by moisture.

Manufacturer:
Uni-Trend Technology (China) Limited
No 6, Gong Ye Bei 1st Road
Songshan Lake National High-Tech Industrial
Development Zone, Dongguan City
Guangdong Province
China
Postal Code: 523 808

Headquarters:
Uni-Trend Group Limited
Rm901, 9/F, Nanyang Plaza
57 Hung To Road
Kwun Tong
Kowloon, Hong Kong
Tel: (852) 2950 9168
Fax: (852) 2950 9303
<http://www.uni-trend.com>

