

TOSHIBA BIPOLAR DIGITAL INTEGRATED CIRCUIT SILICON MONOLITHIC

**TD62101P, TD62101F, TD62103P, TD62103F
TD62104P, TD62104F, TD62105P, TD62105F**

7CH DARLINGTON SINK DRIVER

The TD62101P/F series are high-voltage, high-current darlington drivers comprised of seven NPN darlington pairs.

FEATURES

- Output current (single output) : 500mA (Max.)
- High sustaining voltage output : 25V (Min.)
- Inputs compatible with various types of logic.
- Package type-P : DIP-16 pin.
- Package type-F : SOP-16 pin.

TYPE	INPUT BASE RESISTOR	DESIGNATION
TD62101P/F	External	General Purpose
TD62103P/F	2.7kΩ	TTL, 5V CMOS
TD62104P/F	10.5kΩ	6~15V CMOS, PMOS
TD62105P/F	20kΩ	12~25V CMOS, PMOS

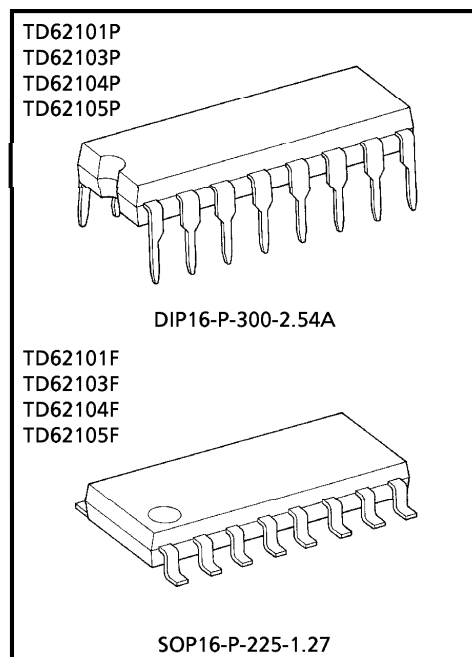

Weight
 DIP16-P-300-2.54A : 1.11g (Typ.)
 SOP16-P-225-1.27 : 0.16g (Typ.)

PIN CONNECTION (TOP VIEW)

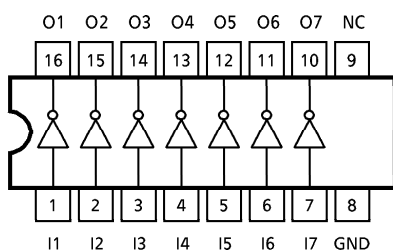

SCHEMATICS (EACH DRIVER)

TD62101P/F

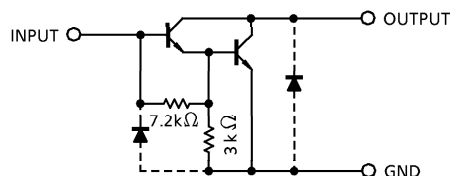

(Note) The input and output parasitic diodes cannot be used as clamp diodes.

961001EBA2

● TOSHIBA is continually working to improve the quality and the reliability of its products. Nevertheless, semiconductor devices in general can malfunction or fail due to their inherent electrical sensitivity and vulnerability to physical stress. It is the responsibility of the buyer, when utilizing TOSHIBA products, to observe standards of safety, and to avoid situations in which a malfunction or failure of a TOSHIBA product could cause loss of human life, bodily injury or damage to property. In developing your designs, please ensure that TOSHIBA products are used within specified operating ranges as set forth in the most recent products specifications. Also, please keep in mind the precautions and conditions set forth in the TOSHIBA Semiconductor Reliability Handbook.

● The products described in this document are subject to foreign exchange and foreign trade control laws.

● The information contained herein is presented only as a guide for the applications of our products. No responsibility is assumed by TOSHIBA CORPORATION for any infringements of intellectual property or other rights of the third parties which may result from its use. No license is granted by implication or otherwise under any intellectual property or other rights of TOSHIBA CORPORATION or others.

● The information contained herein is subject to change without notice.

SCHEMATICS (EACH DRIVER)

TD62103P / F

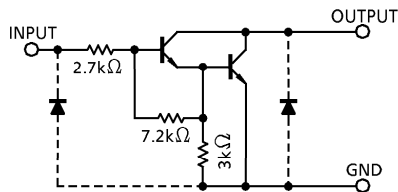

TD62104P / F

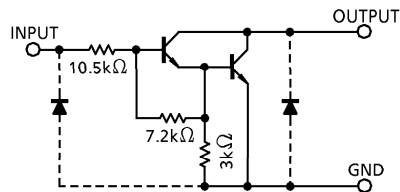

TD62105P / F

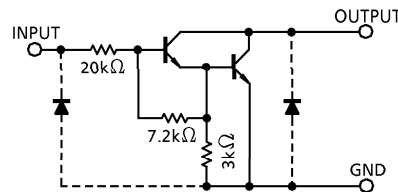

(Note)The input and output parasitic diodes cannot be used as clamp diodes.

MAXIMUM RATINGS (Ta = 25°C)

CHARACTERISTIC		SYMBOL	RATING	UNIT
Output Sustaining Voltage		$V_{CE(SUS)}$	-0.5 ~ 25	V
Output Current		I_{OUT}	500	mA / ch
Input Voltage		V_{IN} (Note 1)	-0.5 ~ 30	V
Input Current		I_{IN} (Note 2)	25	mA
Power Dissipation	P	P_D	1.0	W
	F		0.625 (Note 3)	
Operating Temperature	P	T_{opr}	-30 ~ 75	°C
	F		-40 ~ 85	
Storage Temperature		T_{stg}	-55 ~ 150	°C

(Note 1) Except TD62101P / F

(Note 2) Only TD62101P / F

(Note 3) On Glass Epoxy PCB (30 × 30 × 1.6mm Cu 50%)

RECOMMENDED OPERATING CONDITIONS (Ta = -40 ~ 85°C and Ta = -30 ~ 75°C for only Type-P)

CHARACTERISTIC		SYMBOL	CONDITION	MIN.	TYP.	MAX.	UNIT
Output Sustaining Voltage		$V_{CE(SUS)}$		0	—	25	V
Output Current		I_{OUT}	DC 1 Circuit	0	—	350	mA / ch
			$T_{pw} = 25ms, Duty = 10\%$ 7 Circuits, $T_a = 85°C, T_j = 120°C$	0	—	300	
Input Voltage	Except TD62101P / F	V_{IN}		0	—	20	V
Input Current	Only TD62101P / F	I_{IN}		—	—	10	mA
Power Dissipation	P	P_D	(Note)	—	—	0.44	W
	F			—	—	0.325	

(Note) On Glass Epoxy PCB (30 × 30 × 1.6mm Cu 50%)

ELECTRICAL CHARACTERISTICS (Ta = 25°C)

CHARACTERISTIC		SYMBOL	TEST CIRCUIT	TEST CONDITION	MIN.	TYP.	MAX.	UNIT		
Output Leakage Current	P	I _{CEX}	1	V _{CE} = 25V I _{IN} = 0	Ta = 75°C	—	—	100	μA	
	F				Ta = 85°C	—	—	100		
Collector-Emitter Saturation Voltage		V _{CE (sat)}	2	I _{OUT} = 350mA, I _{IN} = 600μA	—	1.3	2.2	V		
					I _{OUT} = 200mA, I _{IN} = 400μA	—	1.1		2.0	
					I _{OUT} = 100mA, I _{IN} = 200μA	—	1.0		1.8	
DC Current Transfer Ratio		h _{FE}	2	V _{CE} = 2V, I _{OUT} = 350mA	1000	—	—			
Input Current	Output On	I _{IN (ON)}	3	V _{CE} = 2V	I _{OUT} = 350mA	V _{IN} = 1.5V	—	0.25	mA	
						V _{IN} = 1.75V	—	1.00		
						V _{IN} = 2.4V	—	0.4		
						V _{IN} = 13.5V	—	1.2		
						V _{IN} = 20.0V	—	1.0		
	Output Off	I _{IN (OFF)}	4	I _{OUT} = 500μA	Ta = 75°C	50	65	—	μA	
					Ta = 85°C	50	65	—		
Input Voltage	Output On	V _{IN (ON)}	5	V _{CE} = 2V	I _{OUT} = 125mA	—	—	2.1	V	
						—	—	4		
						—	—	6.4		
						I _{OUT} = 250mA	—	—		2.7
							—	—		7
							—	—		12
						I _{OUT} = 350mA	—	—		3.3
							—	—		8.8
							—	—		15
Input Capacitance		C _{IN}	6	V _{IN} = 0, f = 1MHz	—	15	—	pF		
Turn-On Delay		t _{ON}	7	V _{OUT} = 25V, R _L = 70Ω C _L = 15pF	—	0.1	—	μs		
Turn-Off Delay		t _{OFF}			—	0.2	—			

TEST CIRCUIT

1. I_{CEX}

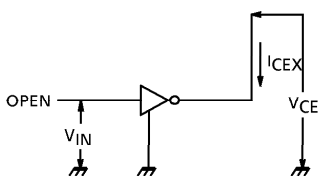

2. h_{FE}, V_{CE (sat)}

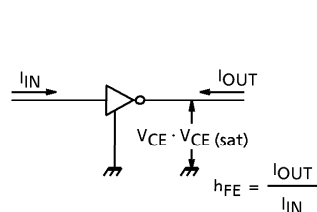

3. I_{IN (ON)}

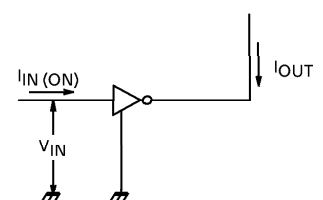

TEST CIRCUIT

4. I_{IN} (OFF)

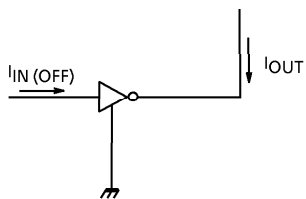

5. V_{IN} (ON)

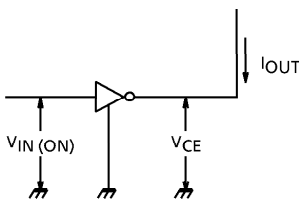

6. C_{IN}

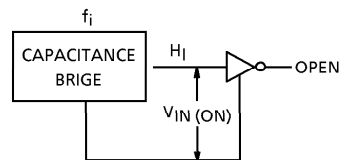

7. t_{ON} , t_{OFF}

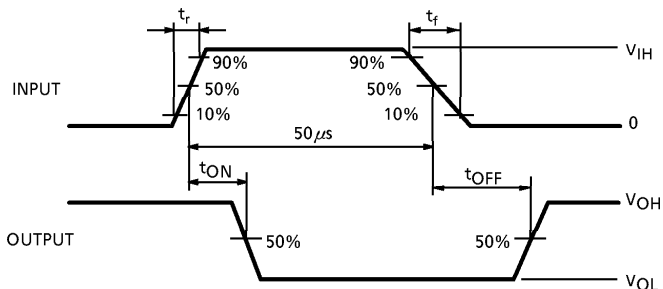
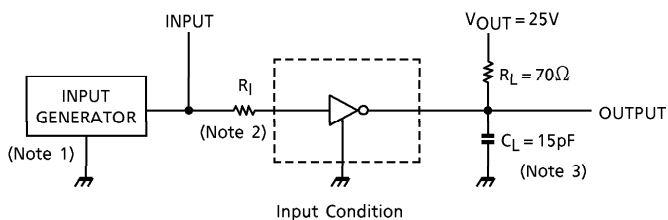

- (Note 1) Pulse Width 50μs, Duty Cycle 10%
Output Impedance 50Ω, $t_r \leq 5ns$, $t_f \leq 10ns$
- (Note 2) See right.
- (Note 3) C_L includes probe and jig capacitance.

INPUT CONDITION

TYPE NUMBER	R_I	V_{IH}
TD62101P / F	2.7kΩ	3V
TD62103P / F	0Ω	3V
TD62104P / F	0Ω	8V
TD62105P / F	0Ω	15V

PRECAUTIONS for USING

Utmost care is necessary in the design of the output line, GND line since IC may be destroyed due to short-circuit between outputs, air contamination fault, or fault by improper grounding.

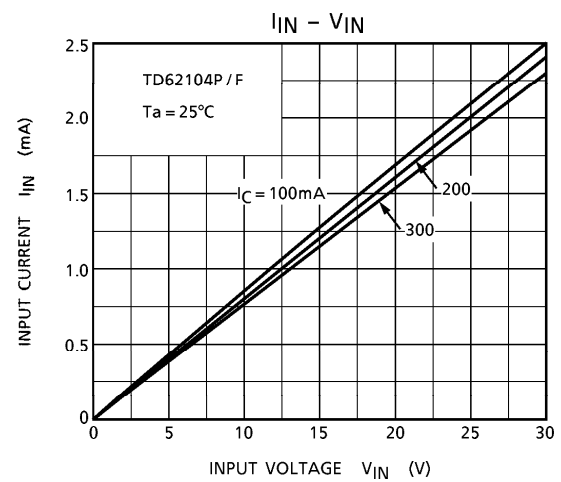
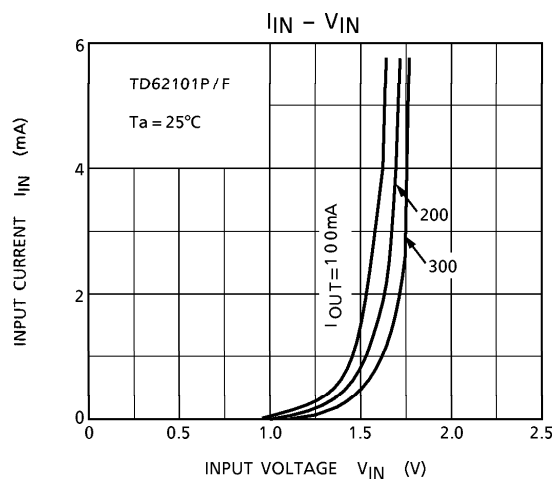
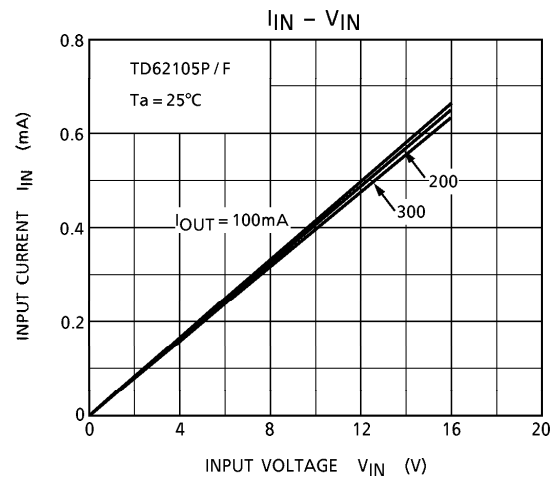
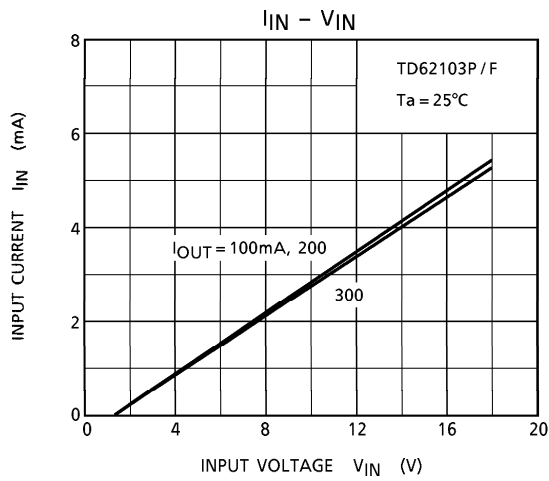
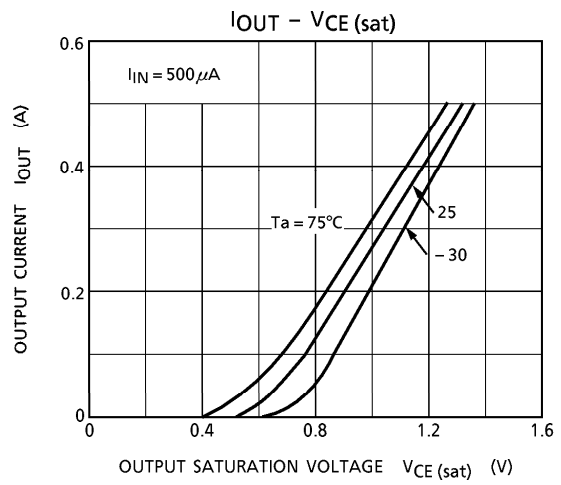
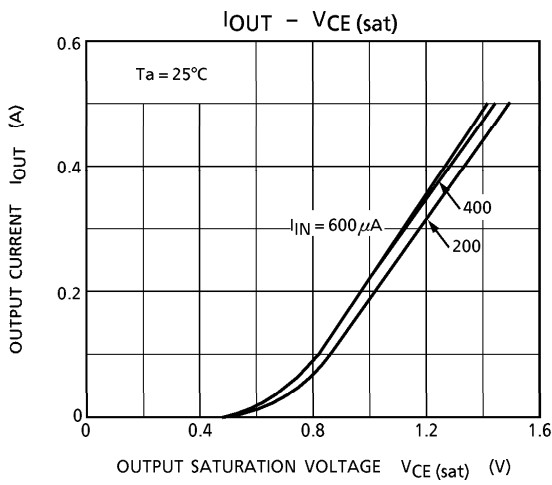

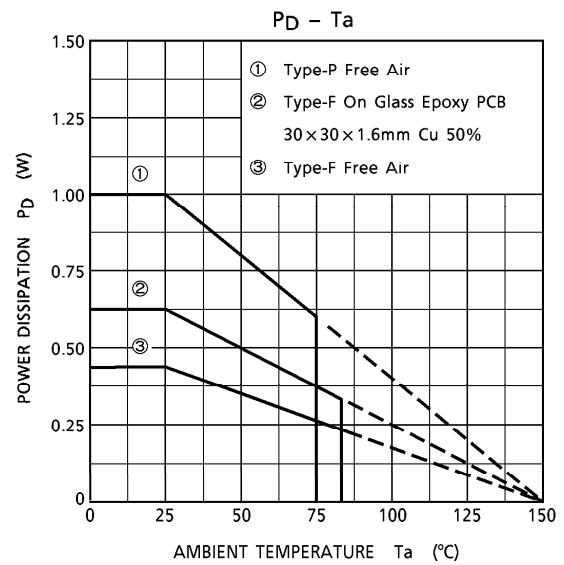
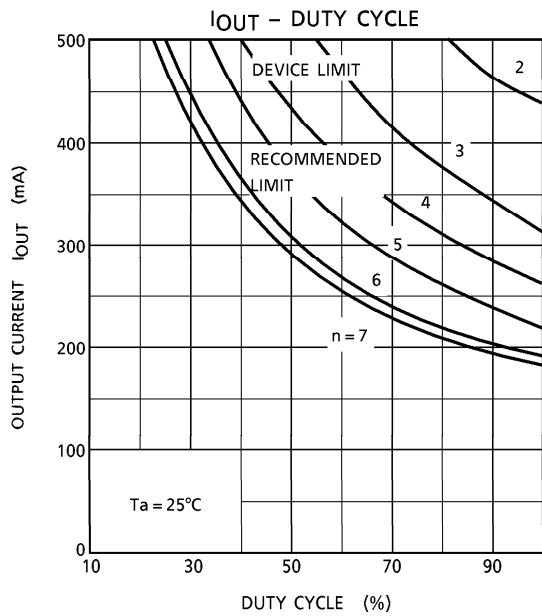
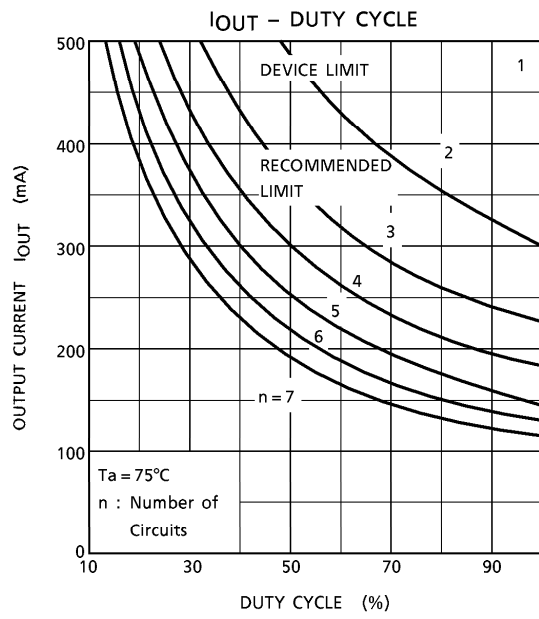
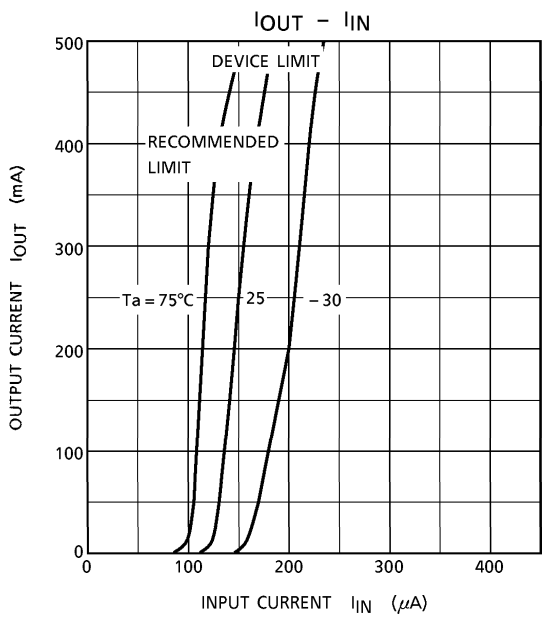

OUTLINE DRAWING
DIP16-P-300-2.54A

Unit : mm

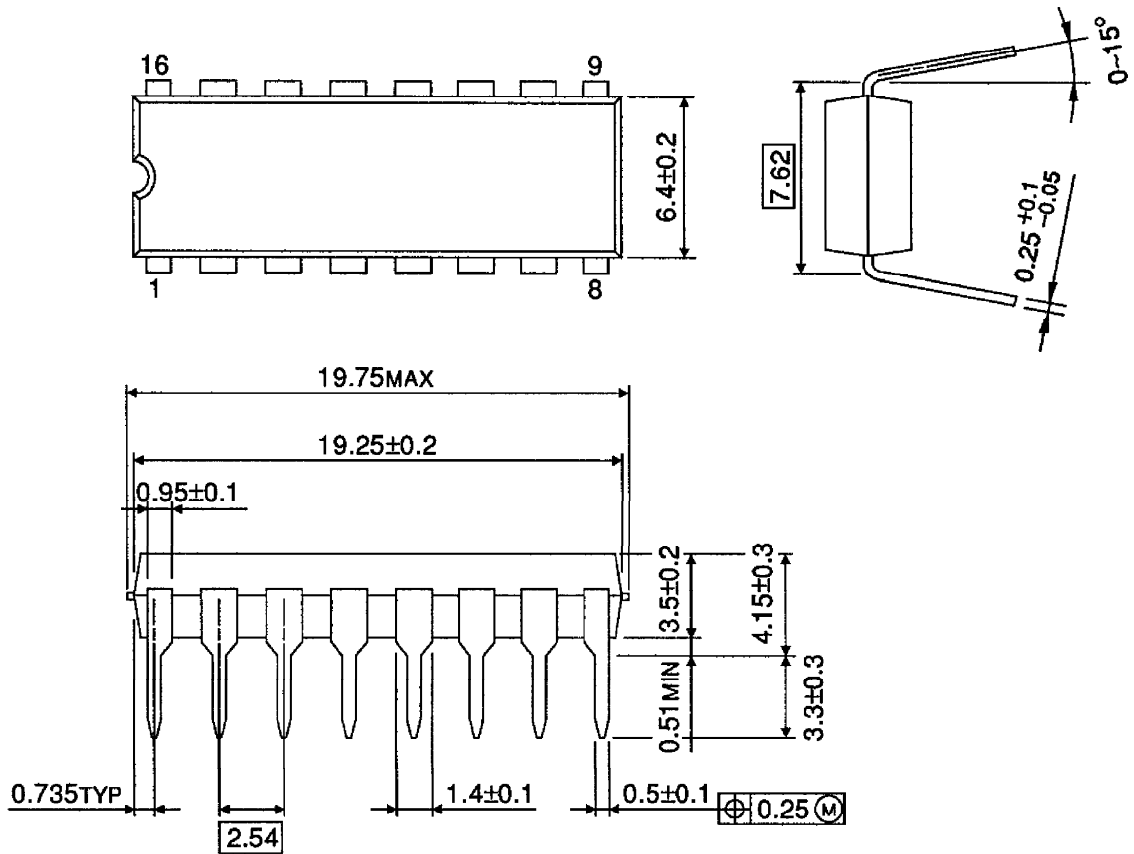

Weight : 1.11g (Typ.)

OUTLINE DRAWING
SOP16-P-225-1.27

Unit : mm

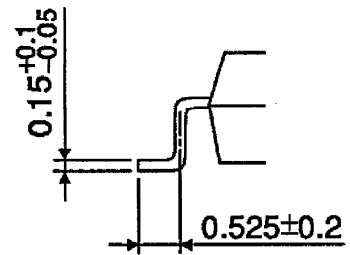
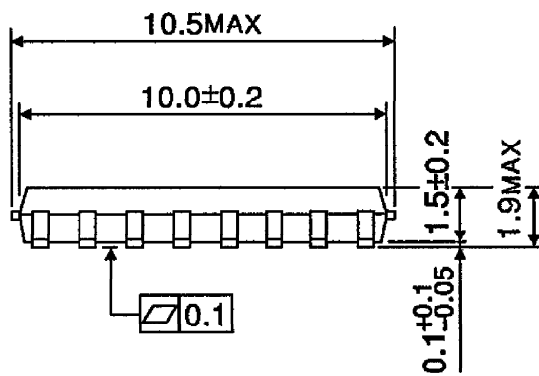
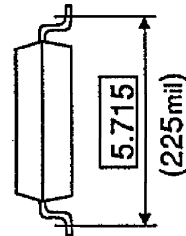
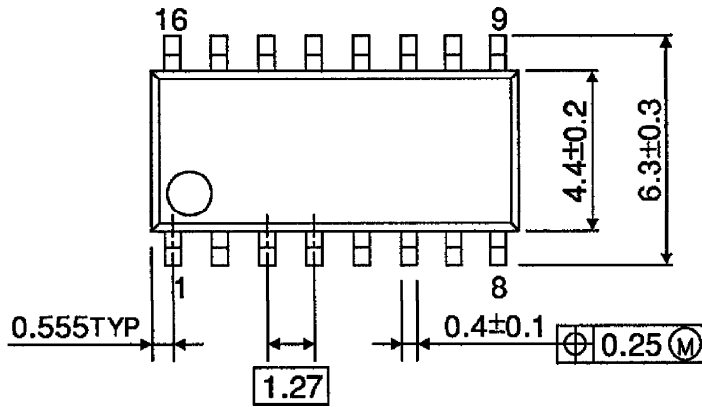

Weight : 0.16g (Typ.)