

# 2SD2549

## Silicon NPN triple diffusion planar type

For power amplification

### ■ Features

- High forward current transfer ratio  $h_{FE}$  which has satisfactory linearity
- Low collector to emitter saturation voltage  $V_{CE(sat)}$
- Full-pack package which can be installed to the heat sink with one screw

### ■ Absolute Maximum Ratings ( $T_C=25^\circ\text{C}$ )

Parameter	Symbol	Rated	Unit	
Collector to base voltage	$V_{CBO}$	80	V	
Collector to emitter voltage	$V_{CEO}$	80	V	
Emitter to base voltage	$V_{EBO}$	6	V	
Peak collector current	$I_{CP}$	5	A	
Collector current	$I_C$	3	A	
Collector power dissipation	$P_C$	$T_C=25^\circ\text{C}$	20	W
		$T_a=25^\circ\text{C}$	2	
Junction temperature	$T_j$	150	$^\circ\text{C}$	
Storage temperature	$T_{stg}$	-55 to +150	$^\circ\text{C}$	

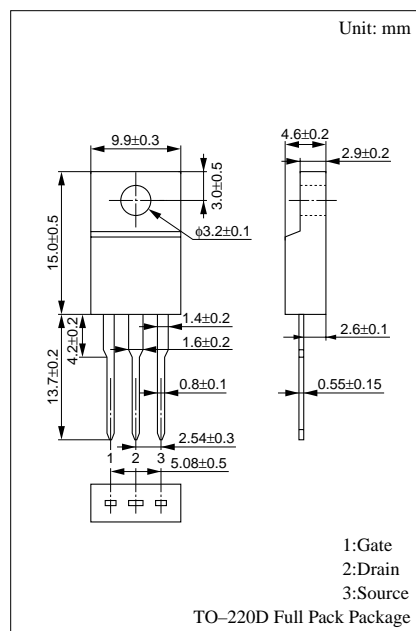

### ■ Electrical Characteristics ( $T_C=25^\circ\text{C}$ )

Parameter	Symbol	Conditions	min	typ	max	Unit
Collector cutoff current	$I_{CES}$	$V_{CE} = 70\text{V}, V_{BE} = 0$			100	$\mu\text{A}$
	$I_{CEO}$	$V_{CE} = 70\text{V}, I_B = 0$			100	$\mu\text{A}$
Emitter cutoff current	$I_{EBO}$	$V_{EB} = 6\text{V}, I_C = 0$			1	mA
Collector to emitter voltage	$V_{CEO}$	$I_C = 30\text{mA}, I_B = 0$	80			V
Forward current transfer ratio	$h_{FE1}^*$	$V_{CE} = 4\text{V}, I_C = 1\text{A}$	70		250	
	$h_{FE2}$	$V_{CE} = 4\text{V}, I_C = 3\text{A}$	10			
Base to emitter voltage	$V_{BE}$	$V_{CE} = 4\text{V}, I_C = 3\text{A}$			1.8	V
Collector to emitter saturation voltage	$V_{CE(sat)}$	$I_C = 3\text{A}, I_B = 0.375\text{A}$			0.7	V
Transition frequency	$f_T$	$V_{CE} = 10\text{V}, I_C = 0.5\text{A}, f = 10\text{MHz}$		30		MHz
Turn-on time	$t_{on}$	$I_C = 1\text{A}, I_{B1} = 0.1\text{A}, I_{B2} = -0.1\text{A}, V_{CC} = 50\text{V}$			0.5	$\mu\text{s}$
Storage time	$t_{stg}$				4.5	$\mu\text{s}$
Fall time	$t_f$				0.5	$\mu\text{s}$

\* $h_{FE1}$  Rank classification

Rank	Q	P
$h_{FE1}$	70 to 150	120 to 250

$P_C - T_a$

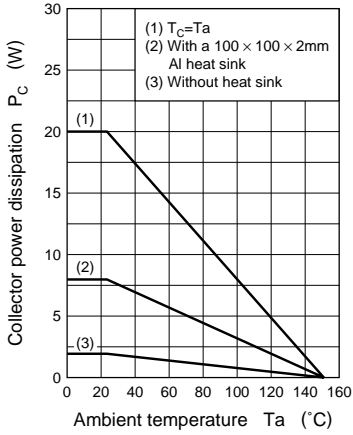

$I_C - V_{CE}$

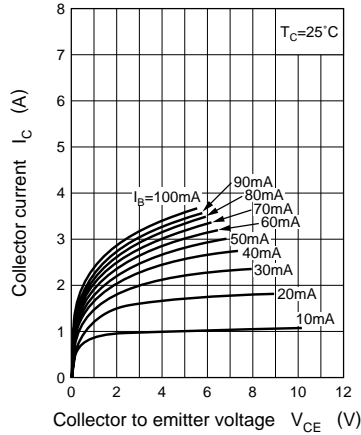

$I_C - V_{BE}$

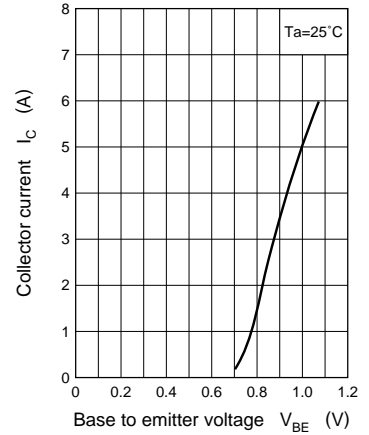

$V_{CE(sat)} - I_C$

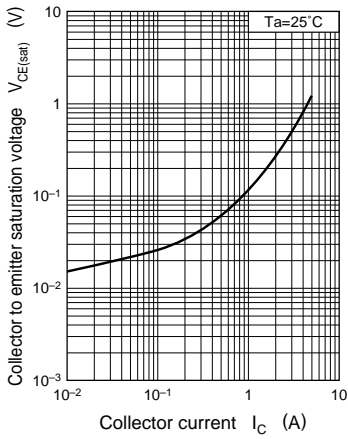

$h_{FE} - I_C$

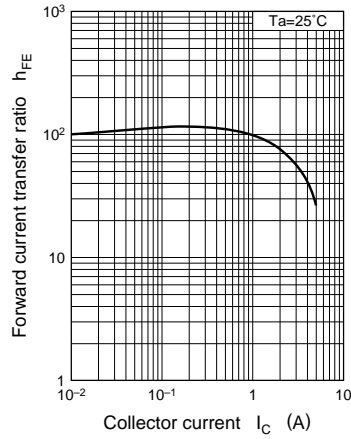

Area of safe operation (ASO)

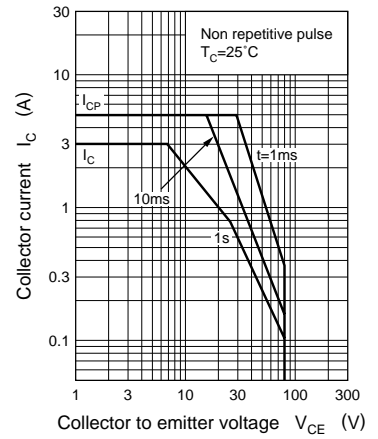

$R_{th(t)} - t$

